

I X A V E R

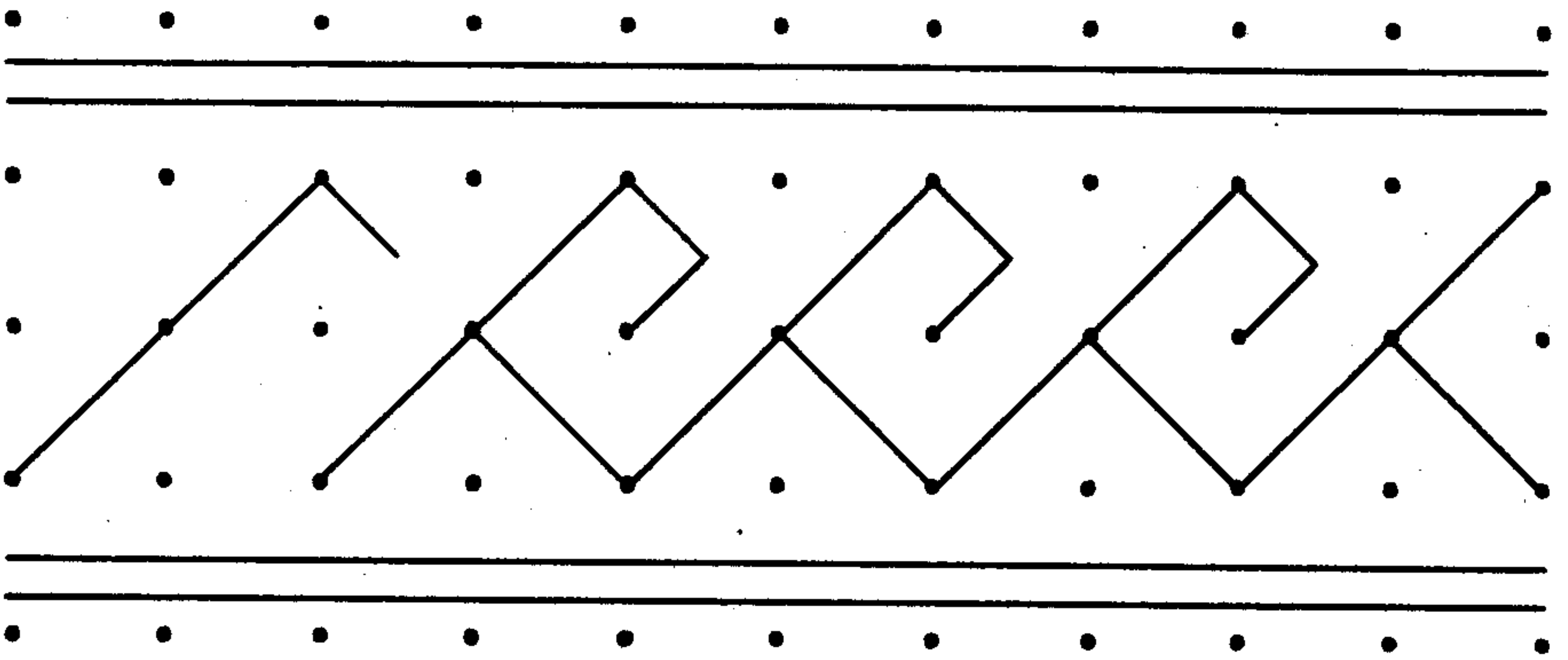

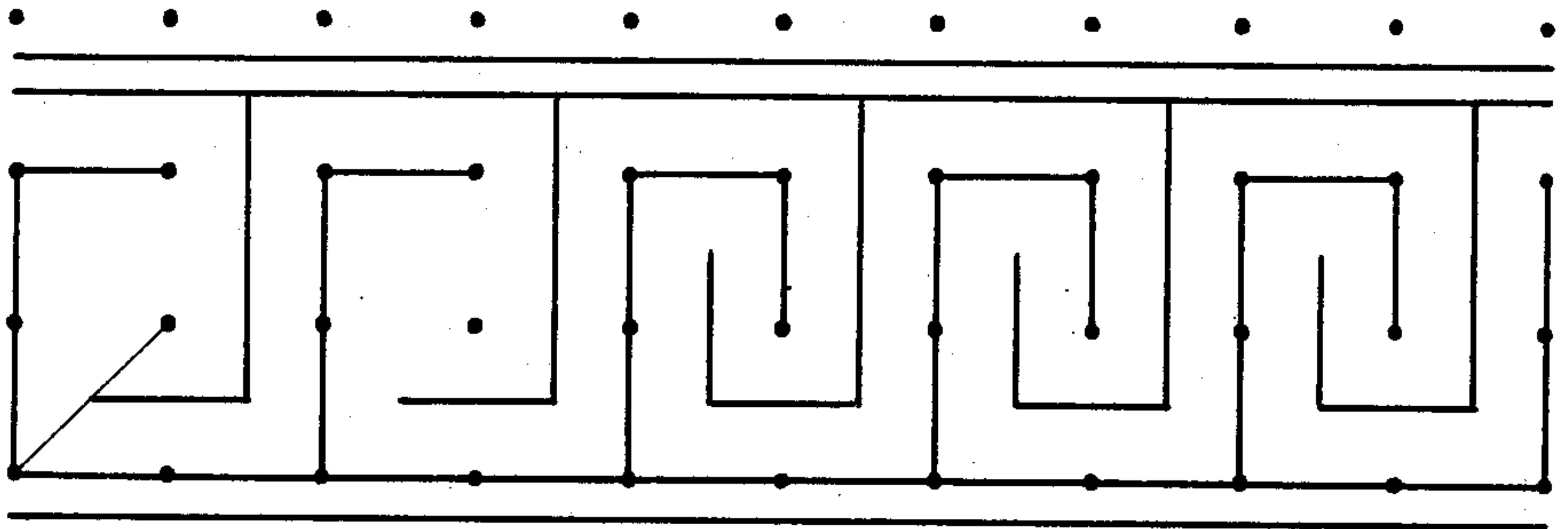

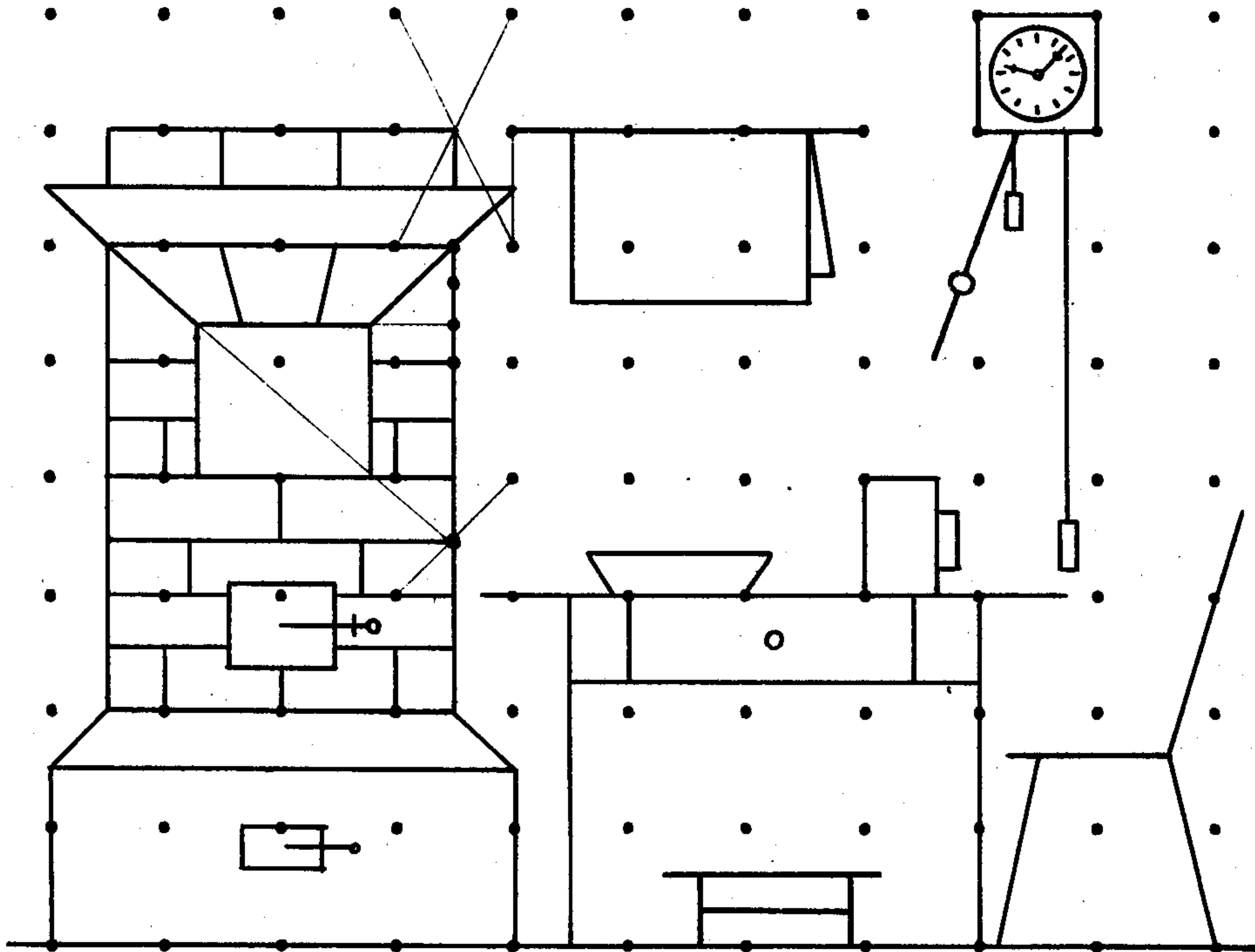

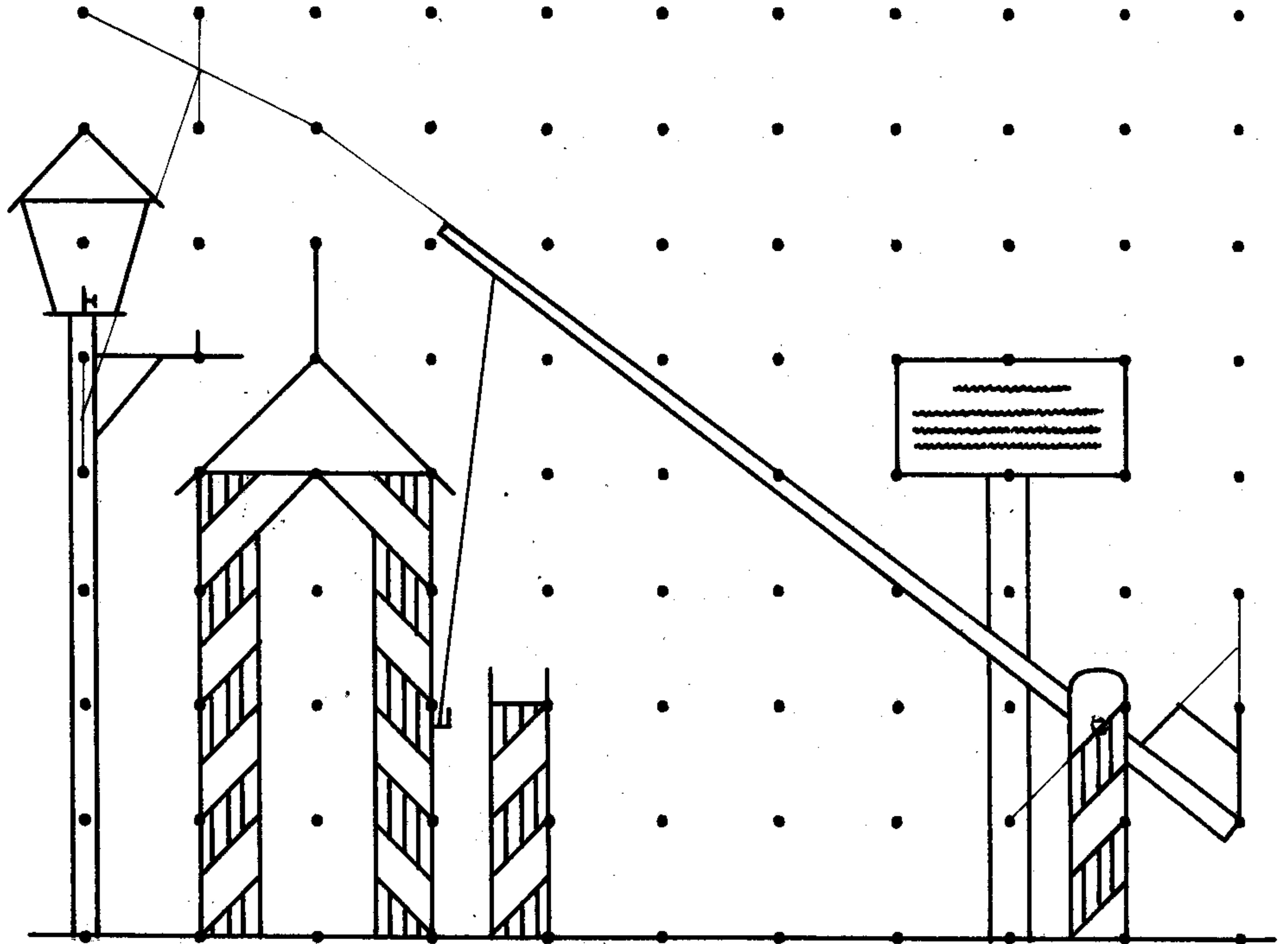
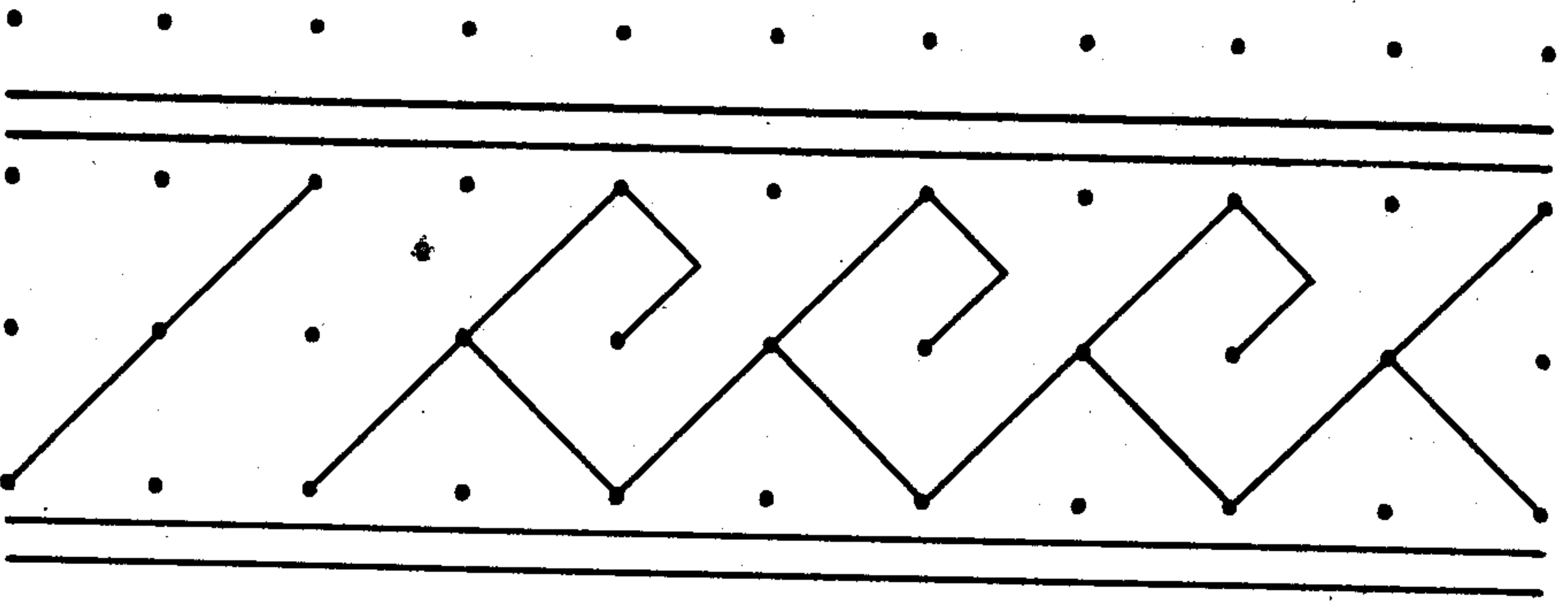
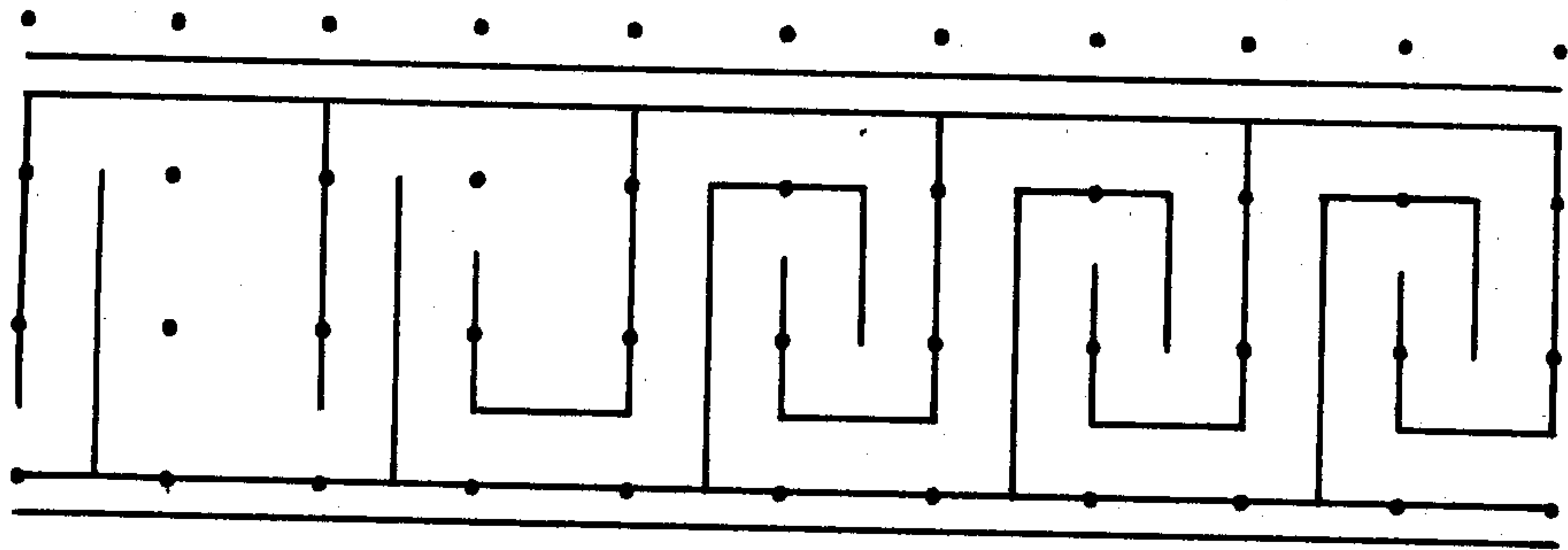

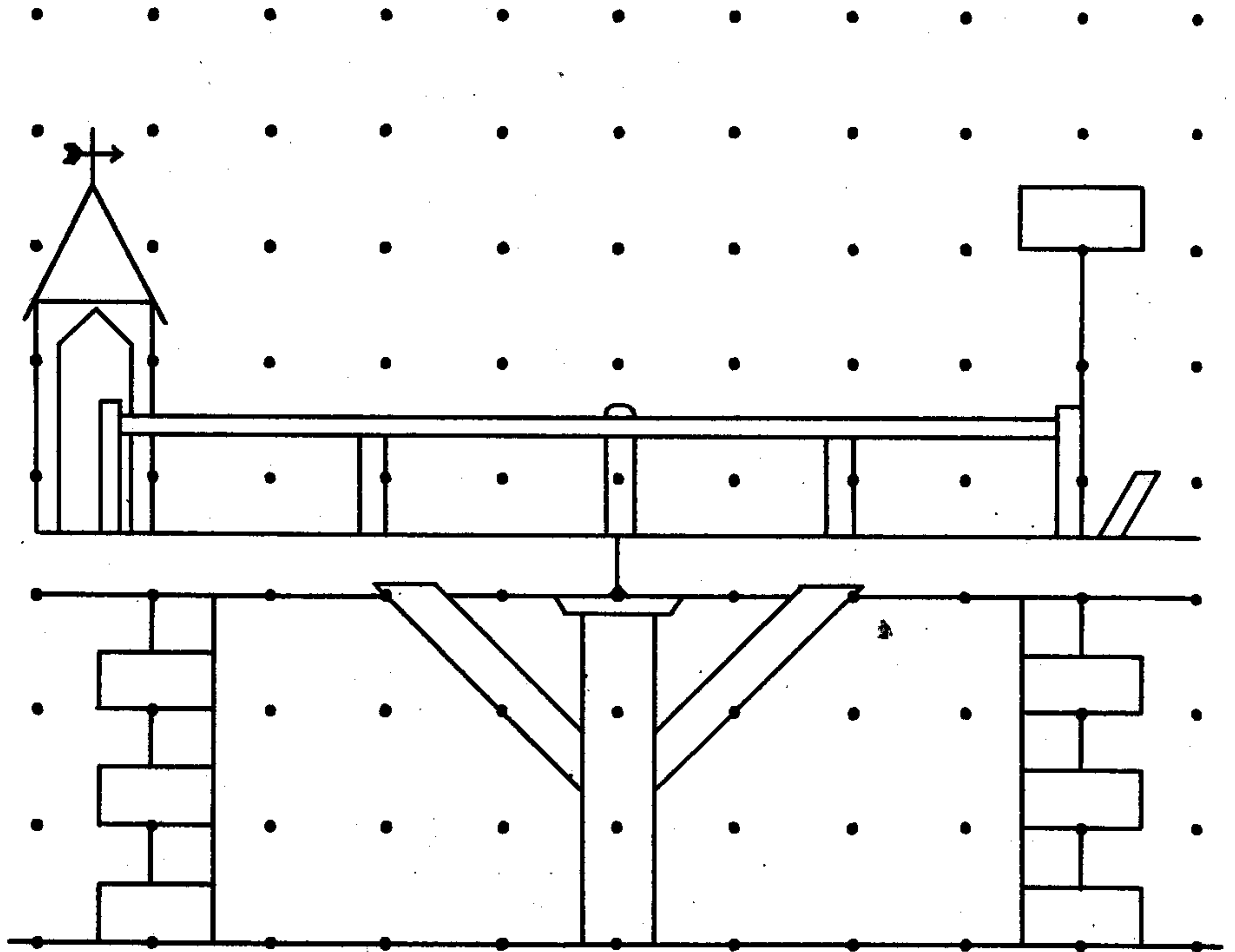

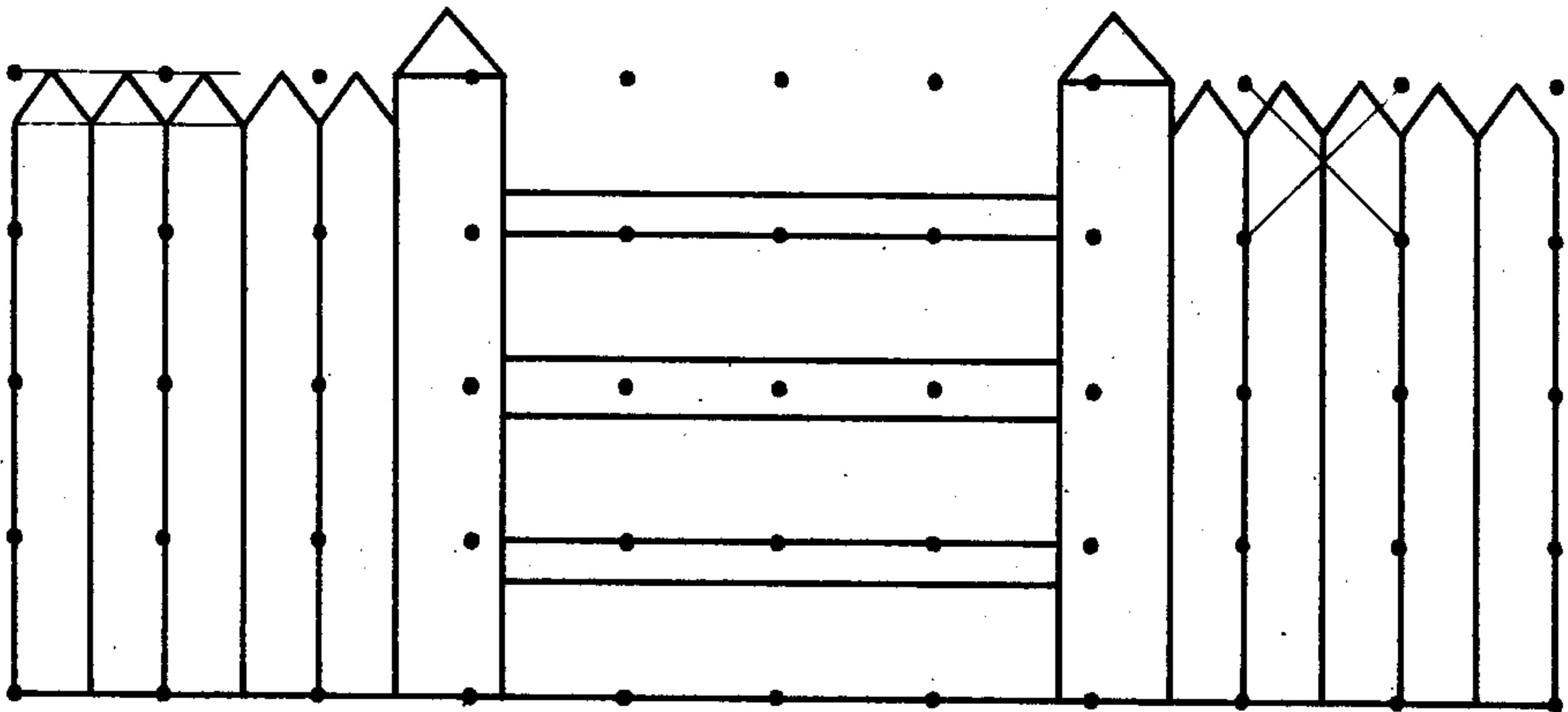
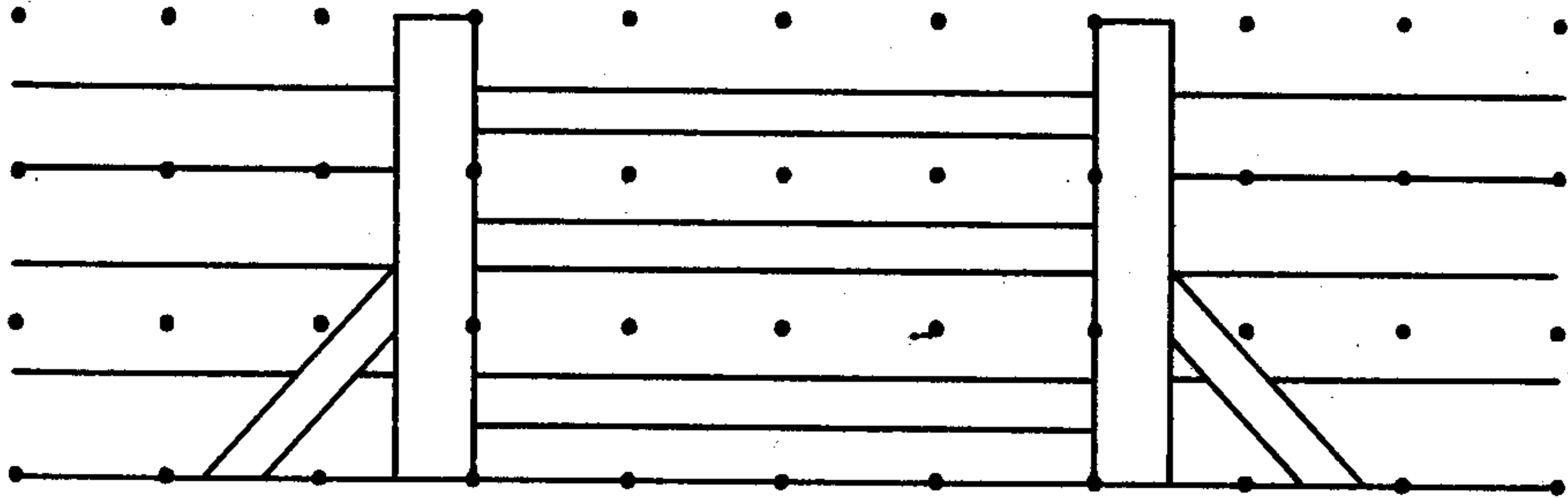

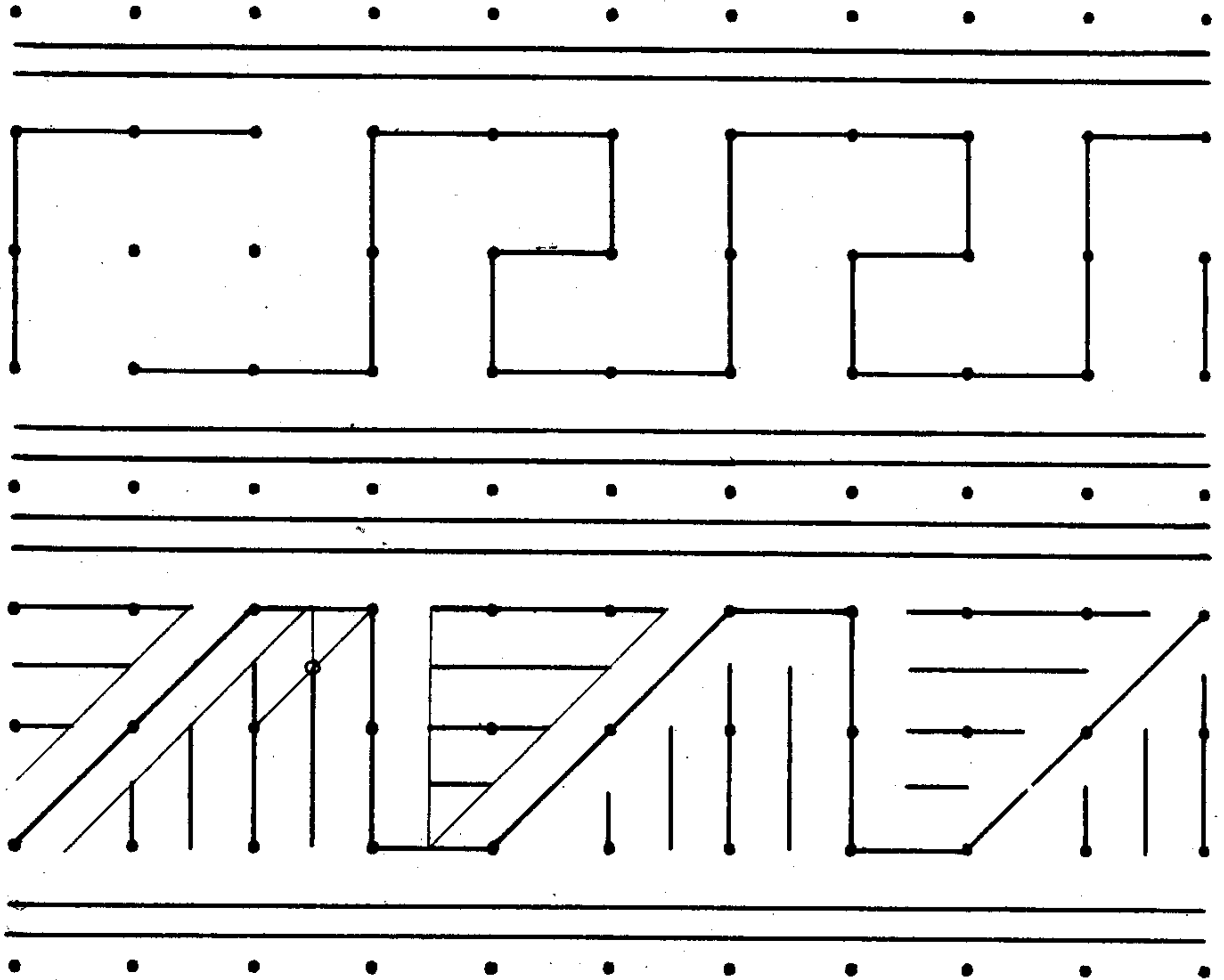

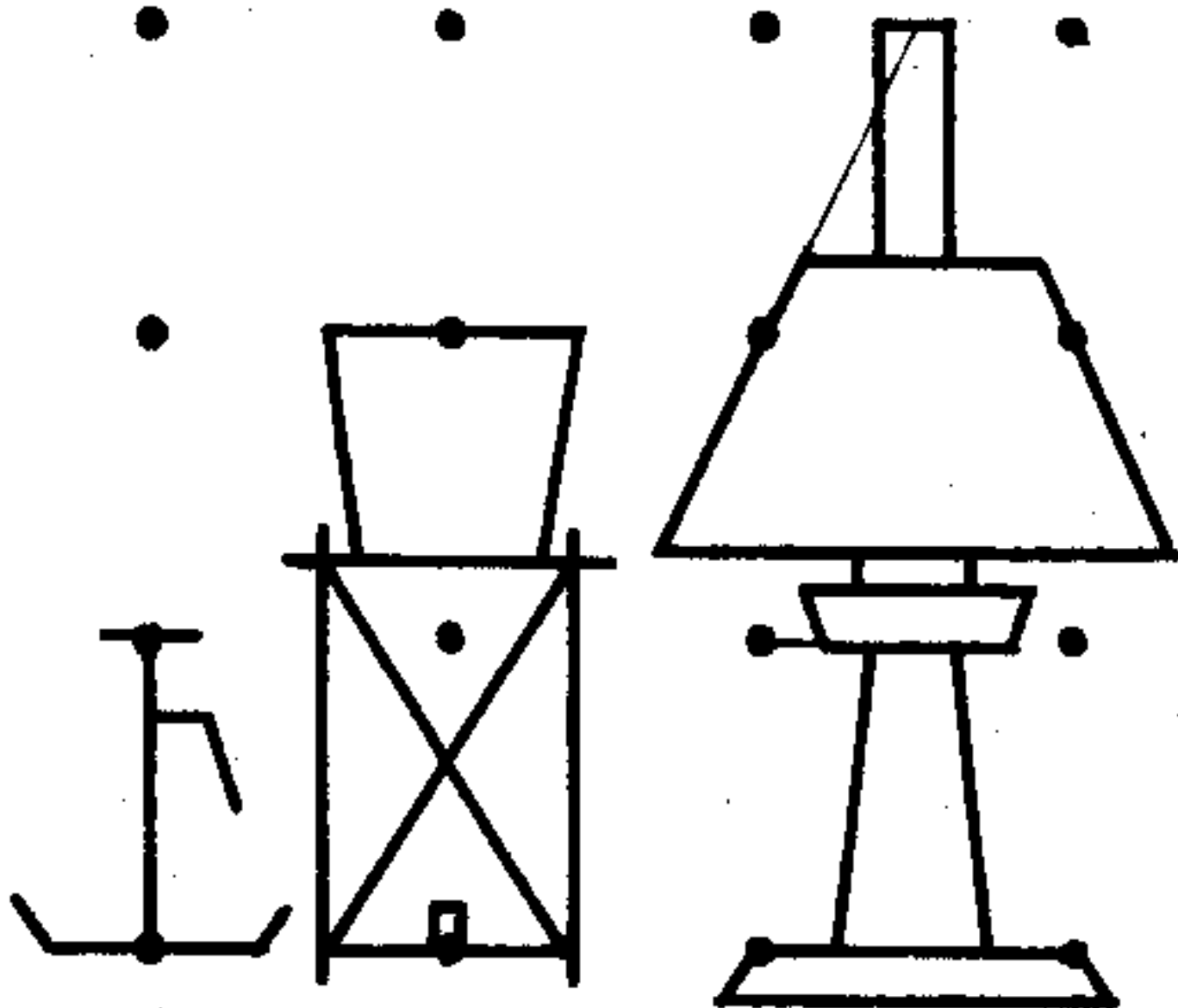
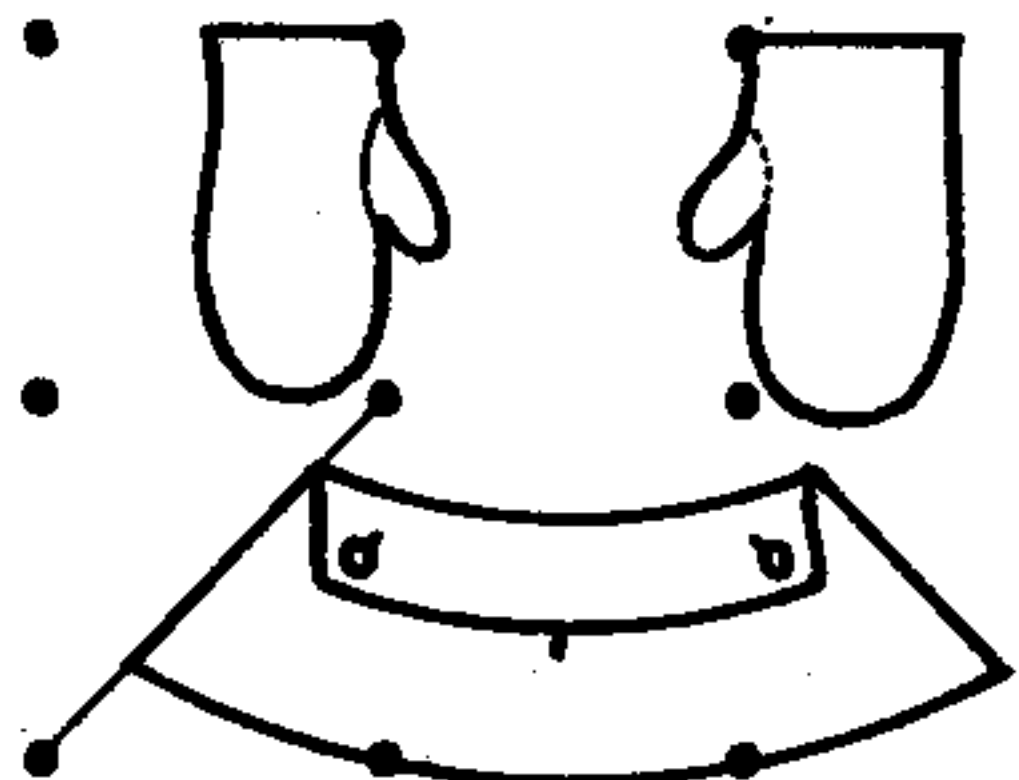
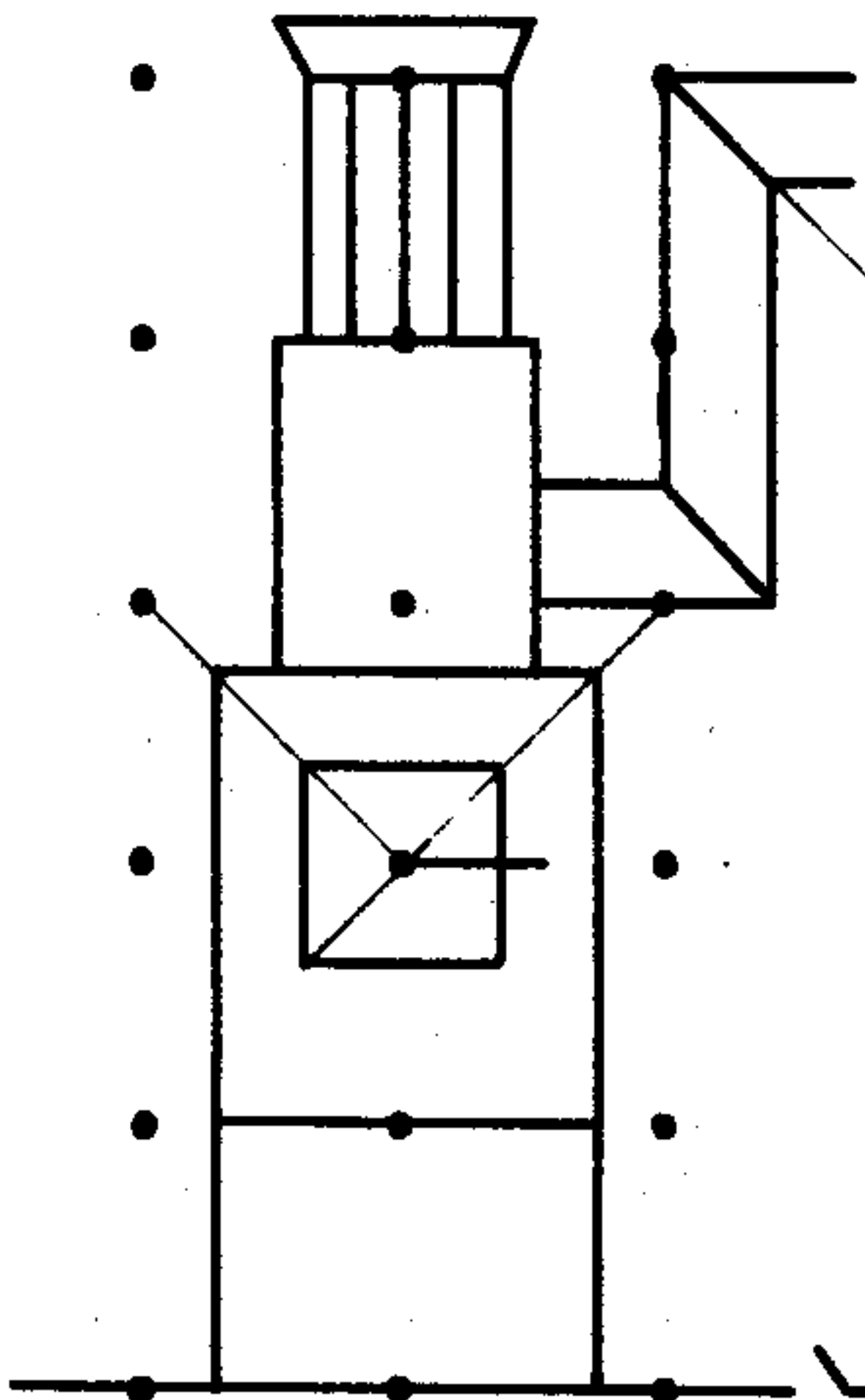
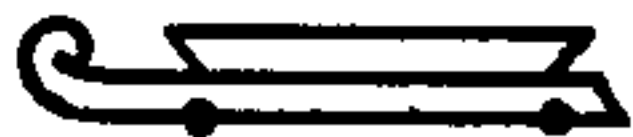
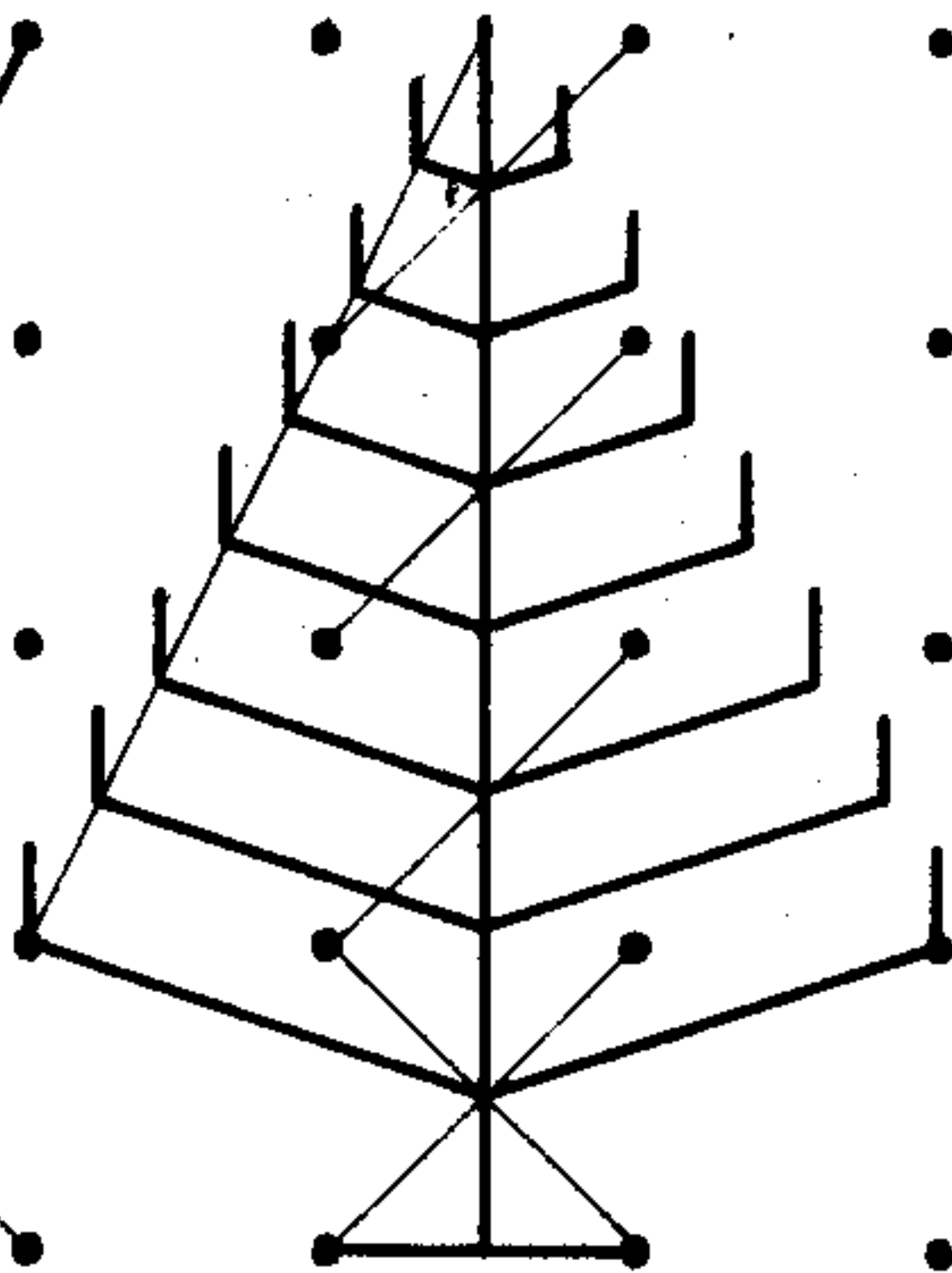
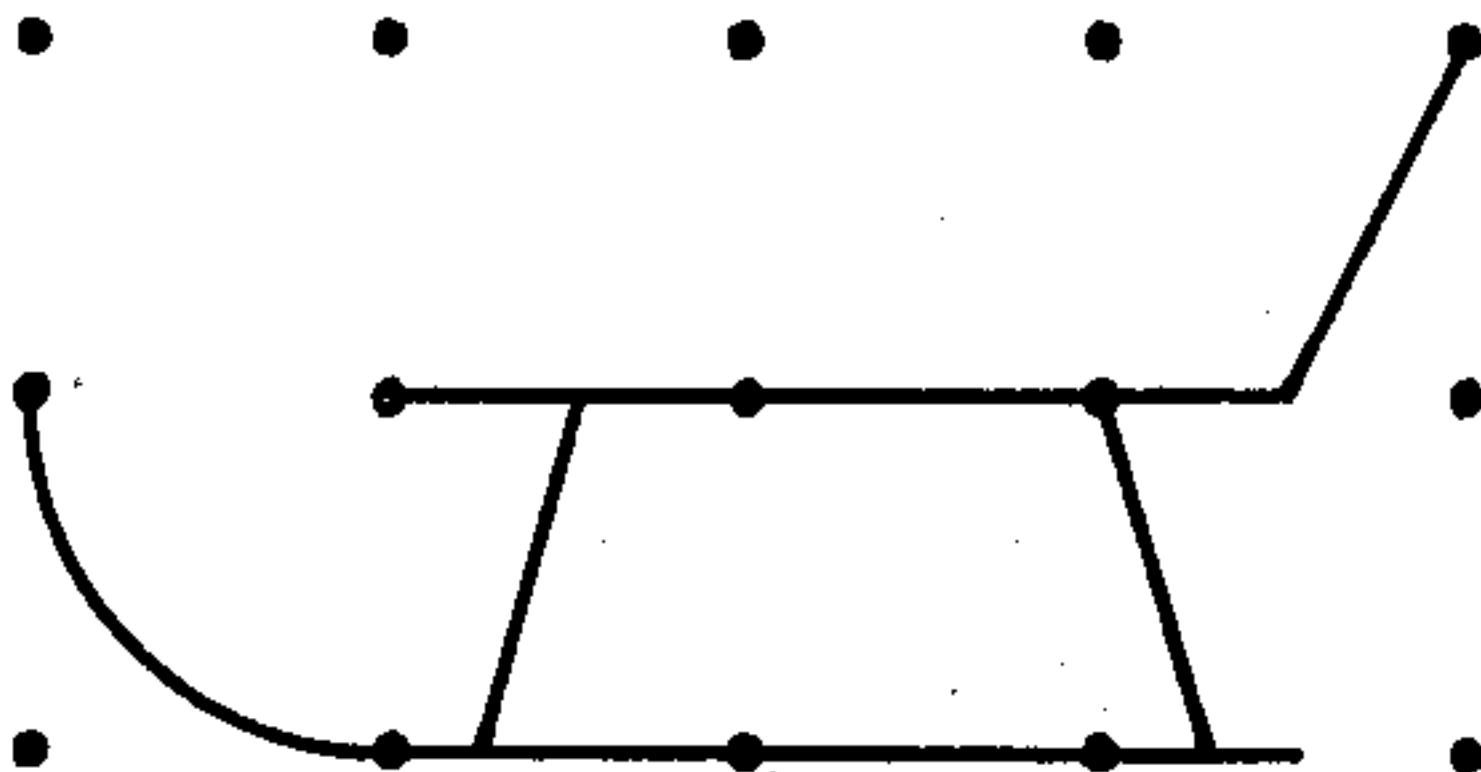
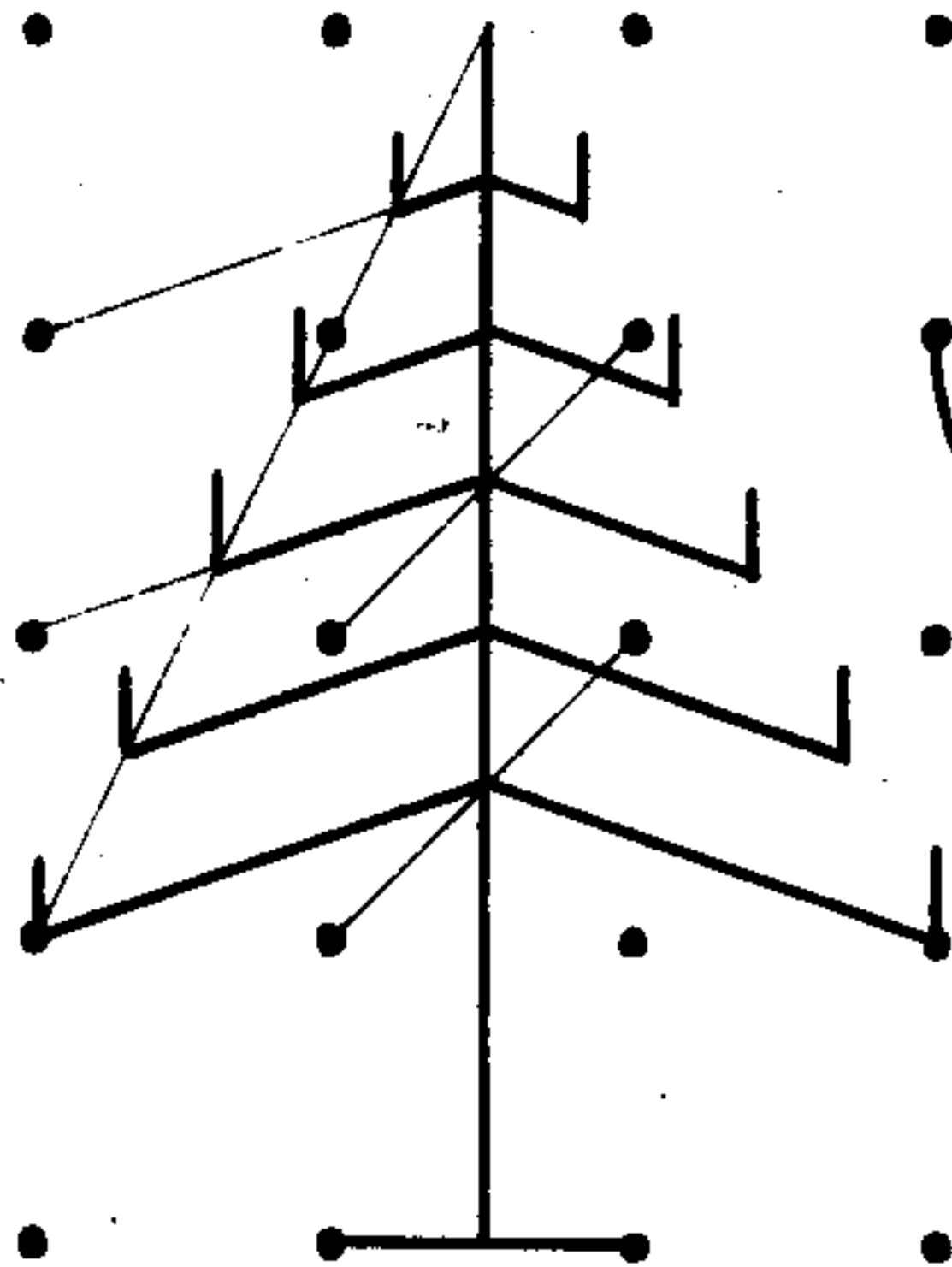

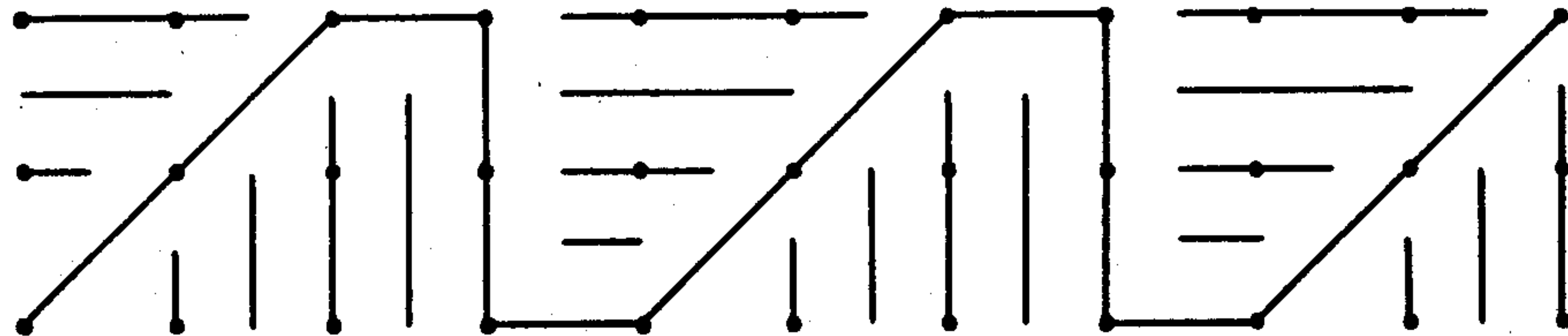
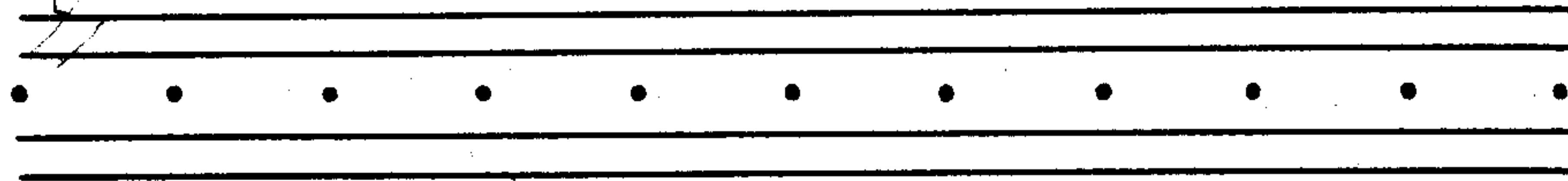
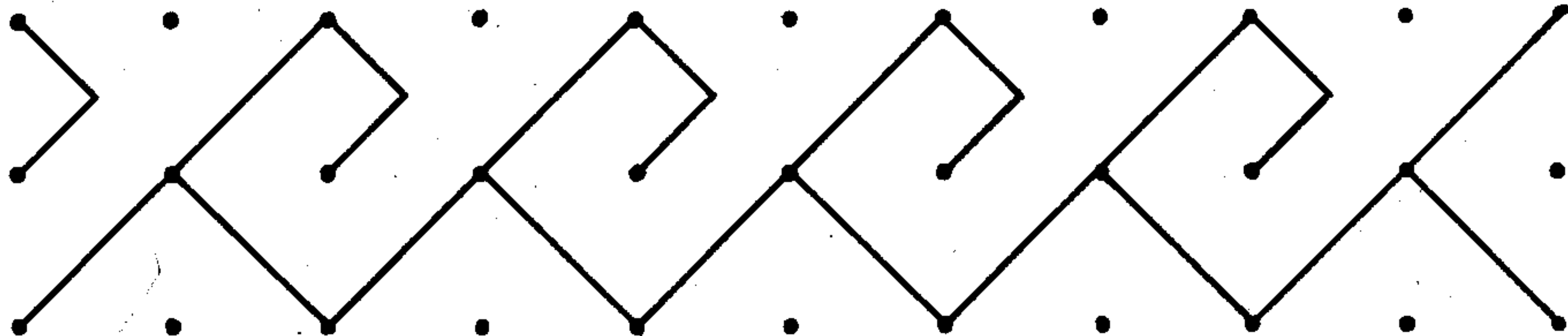

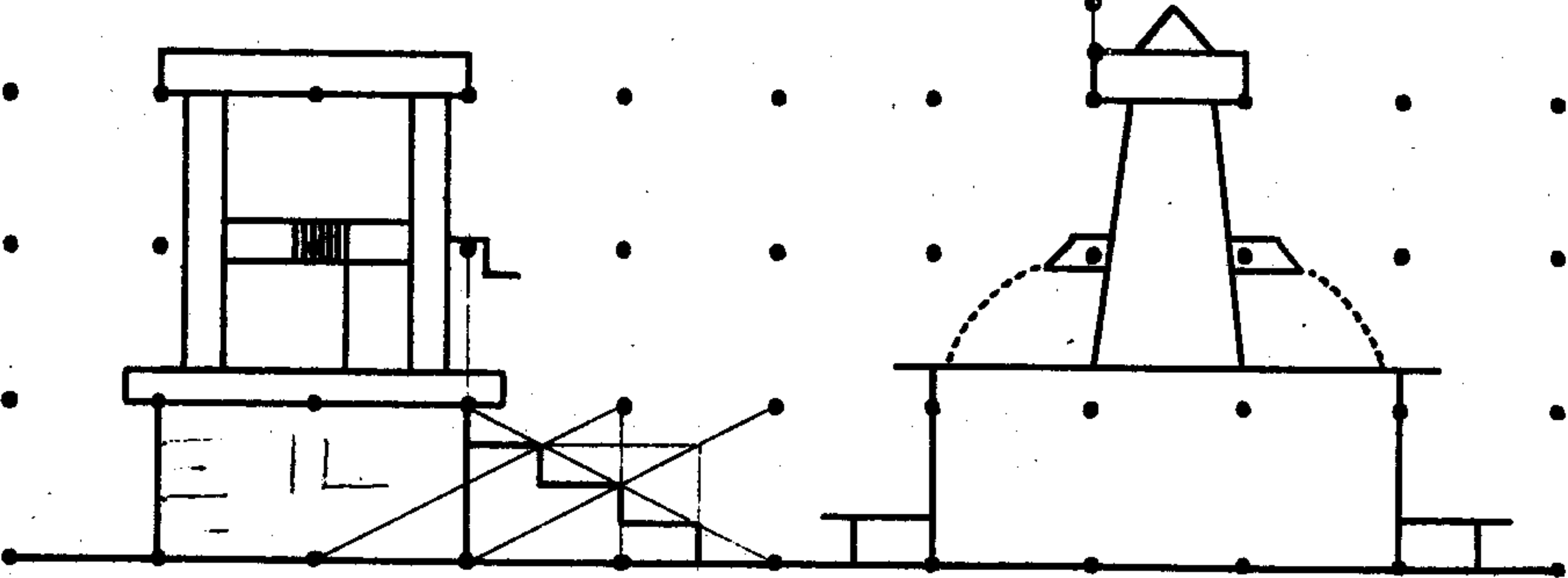
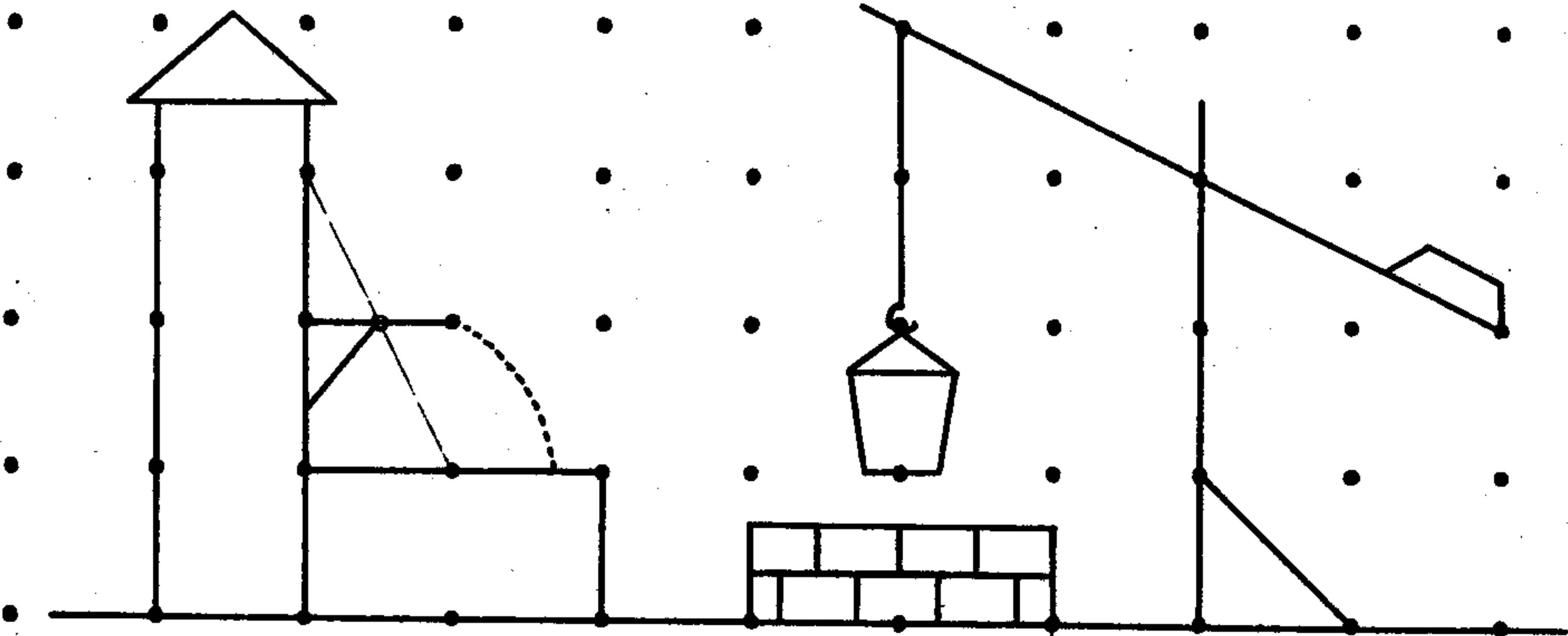

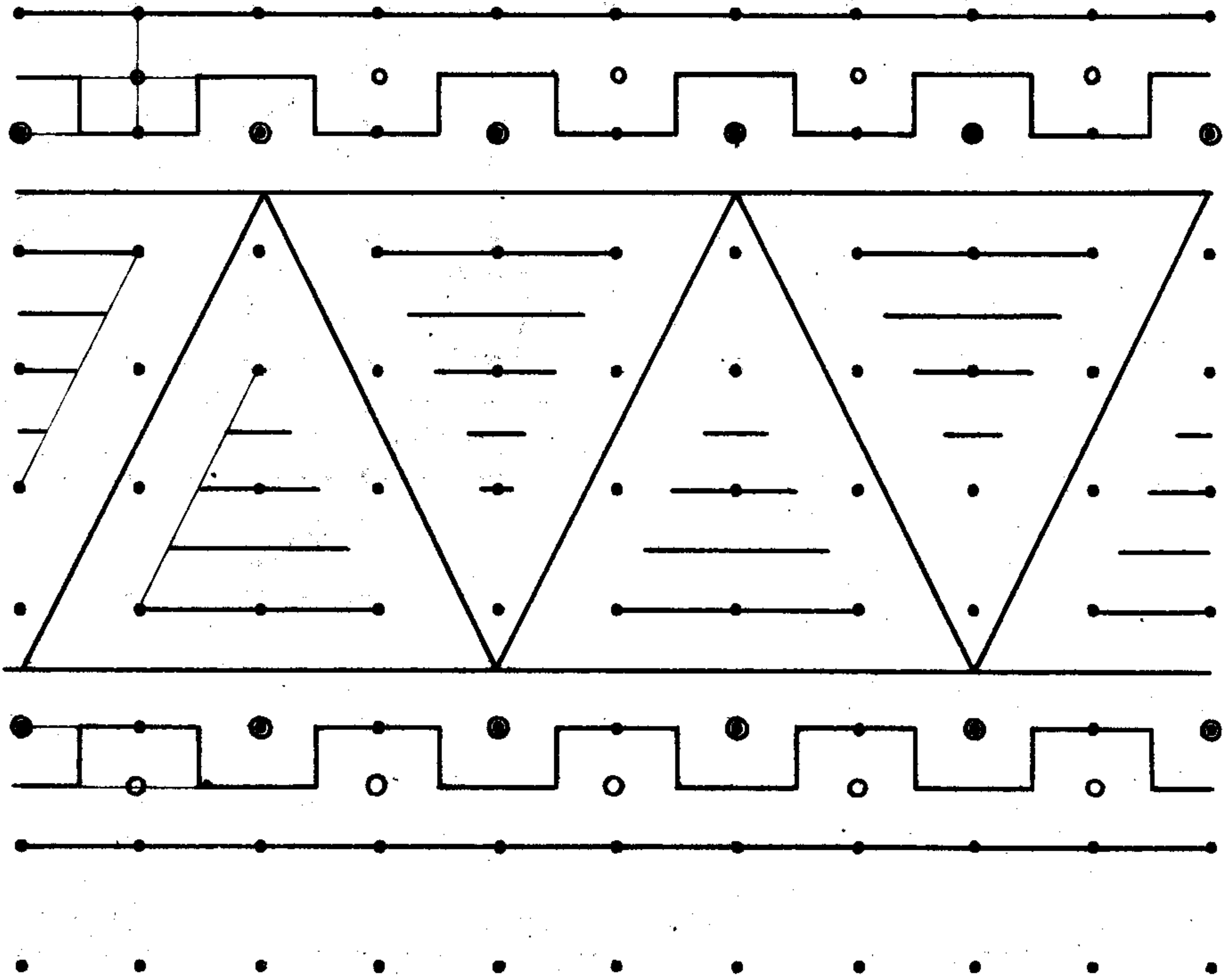

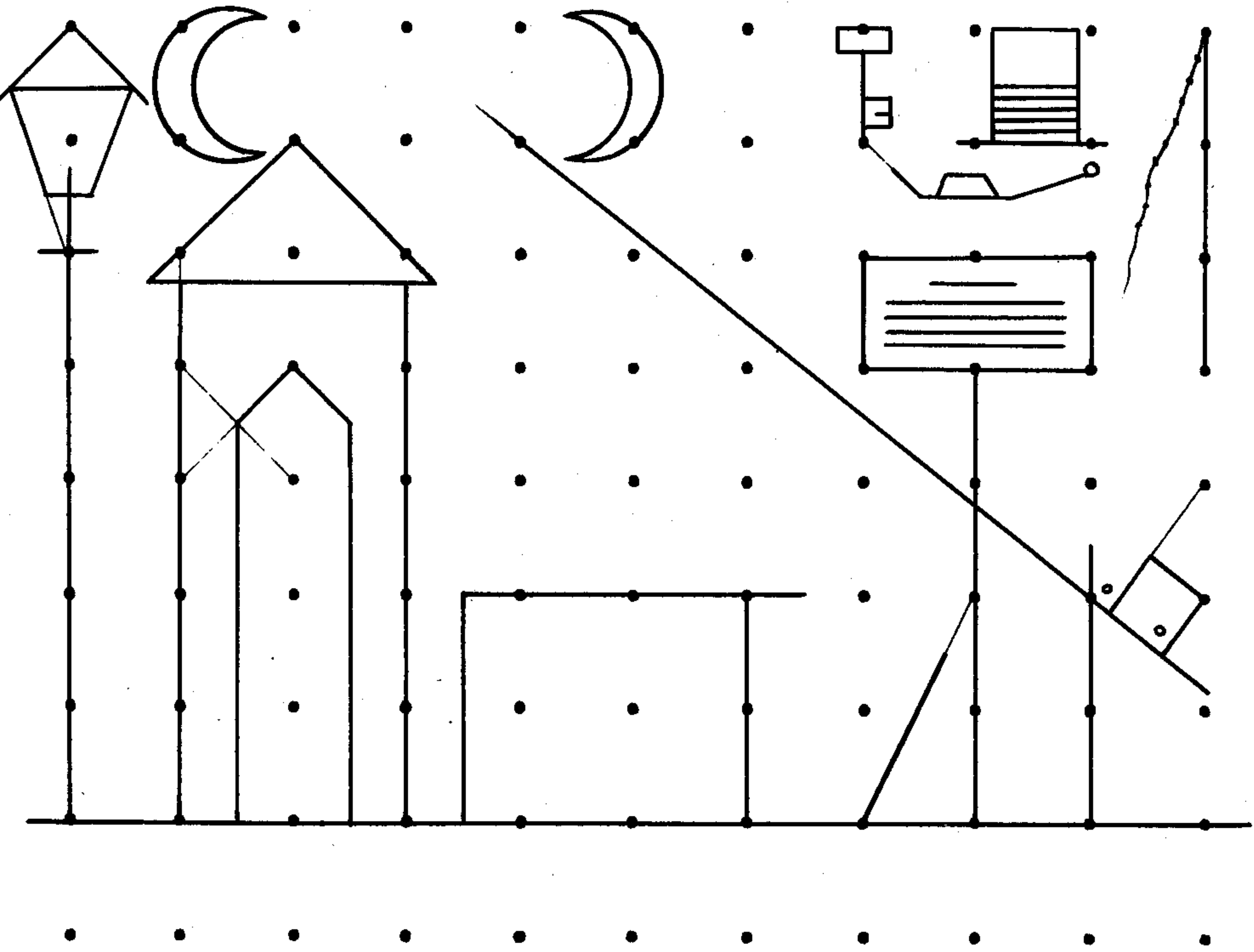

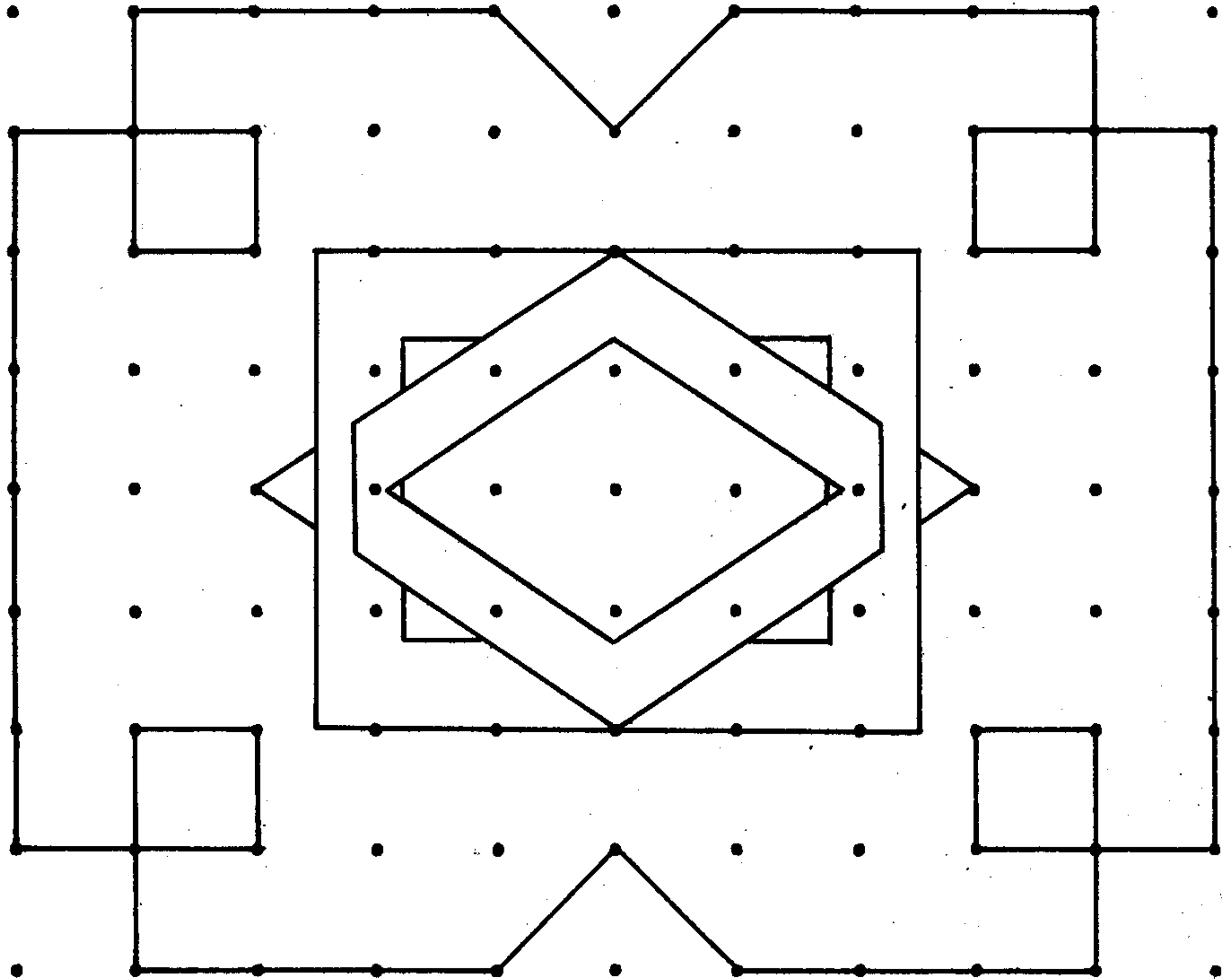

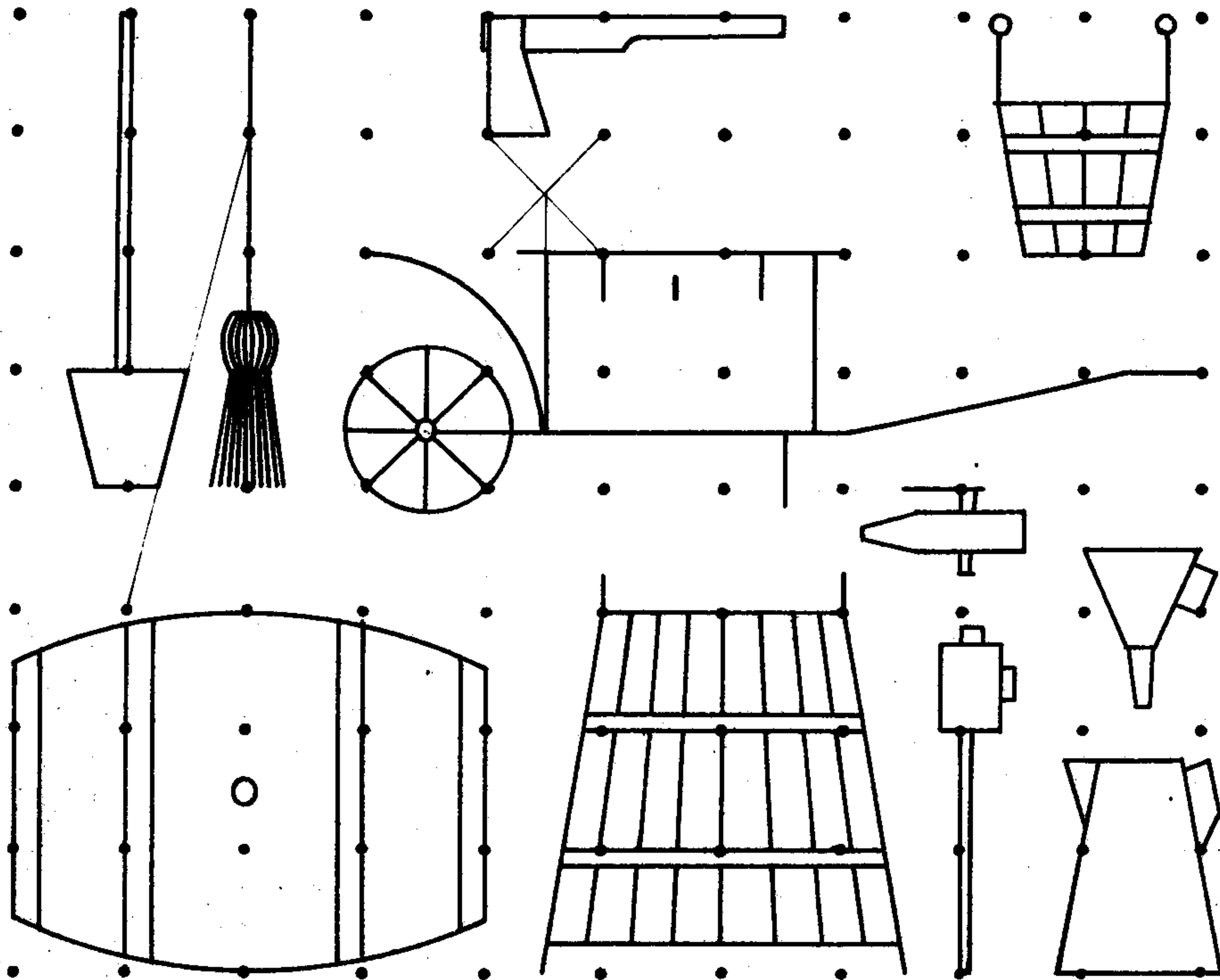

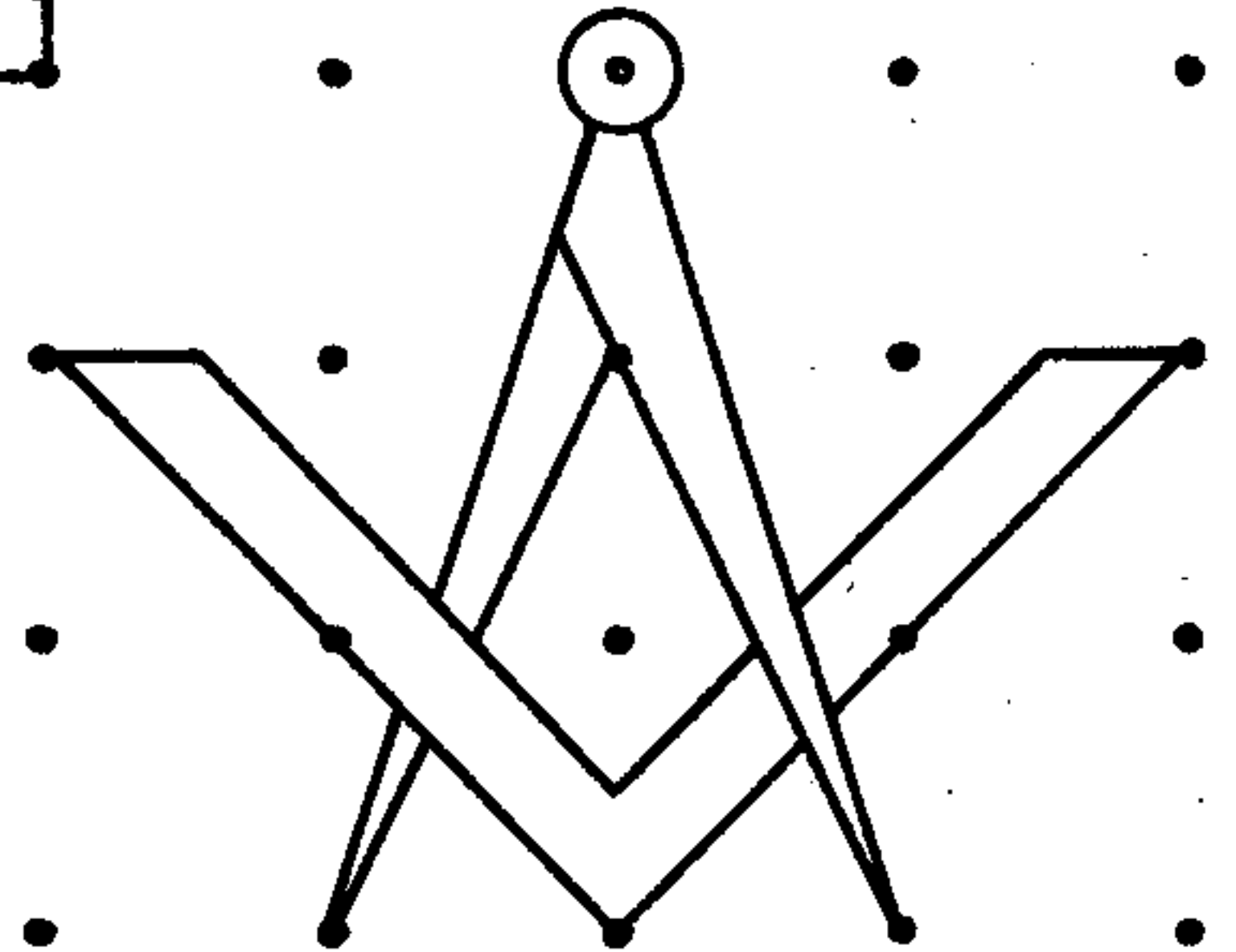
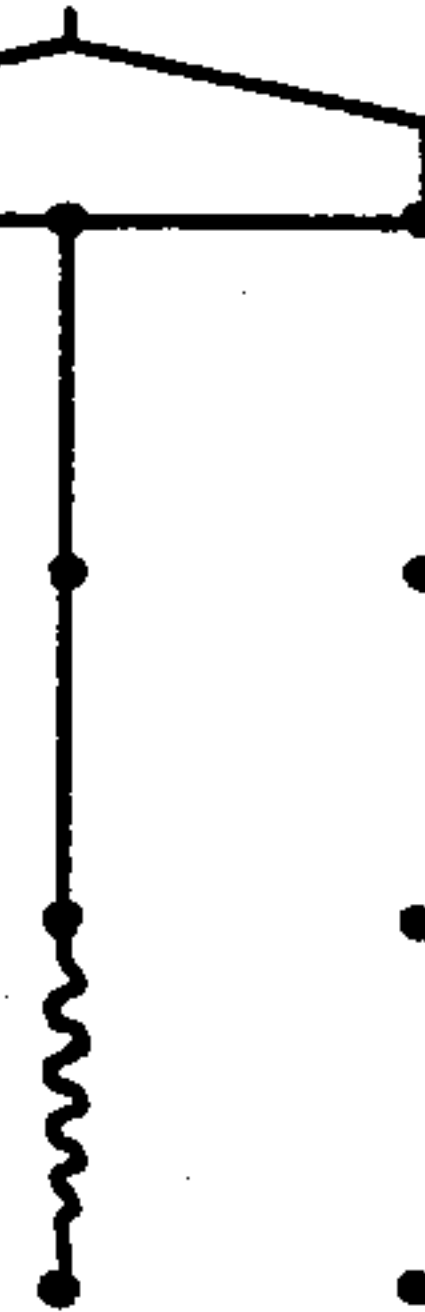
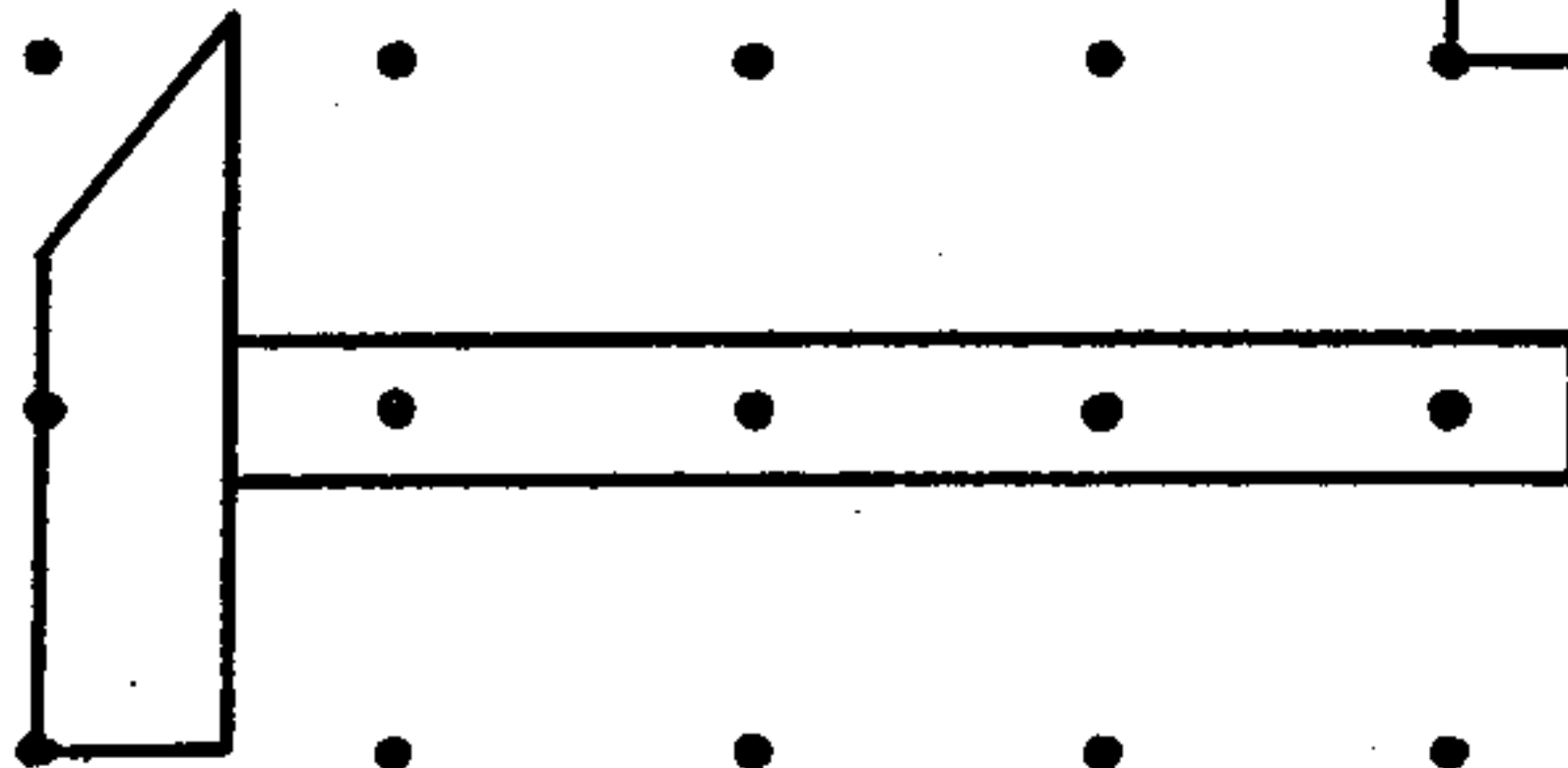
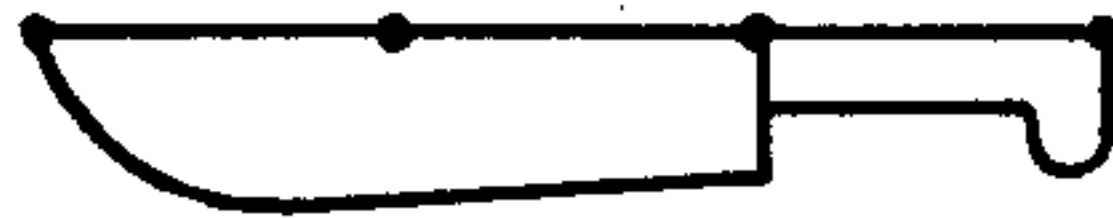
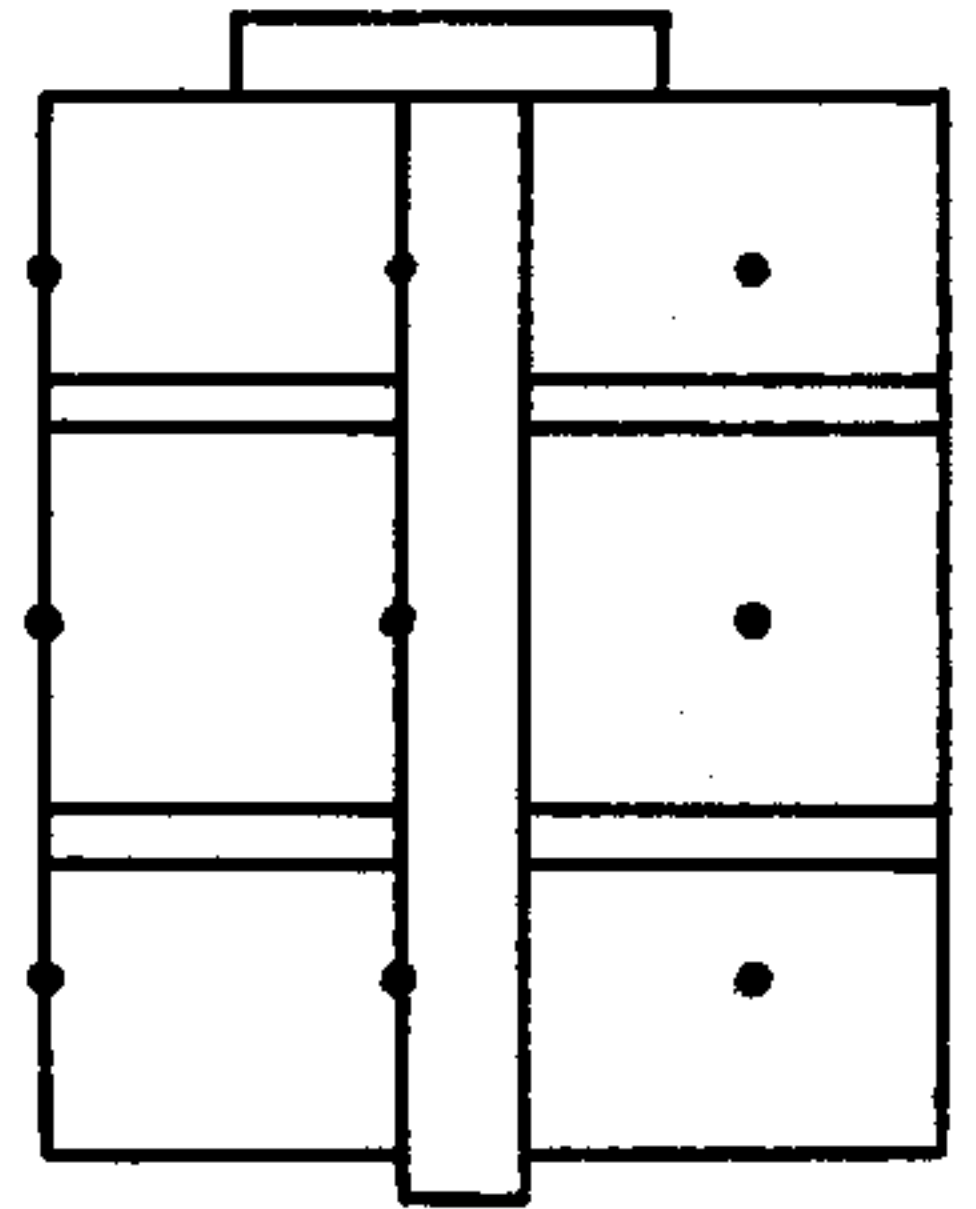
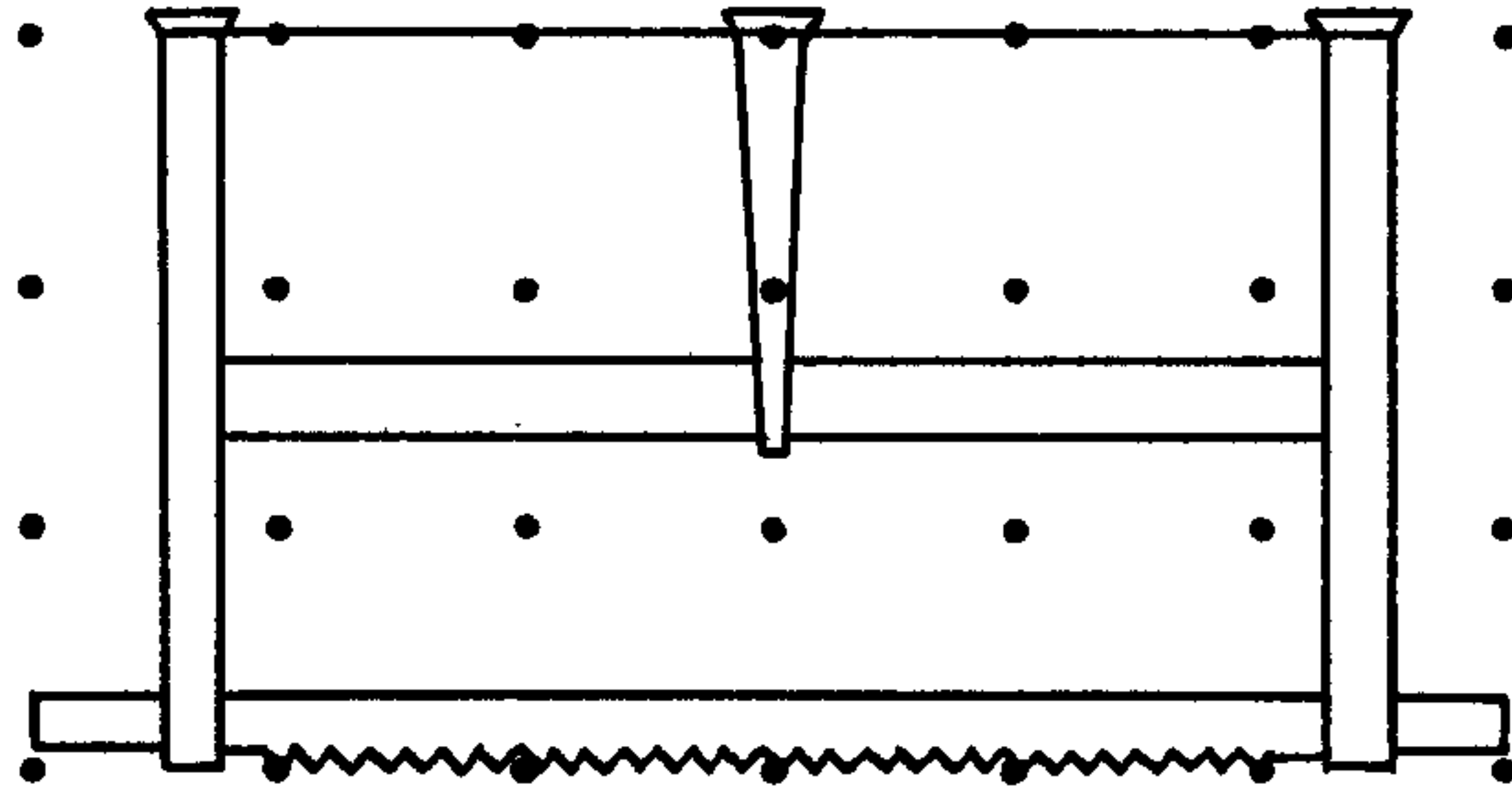

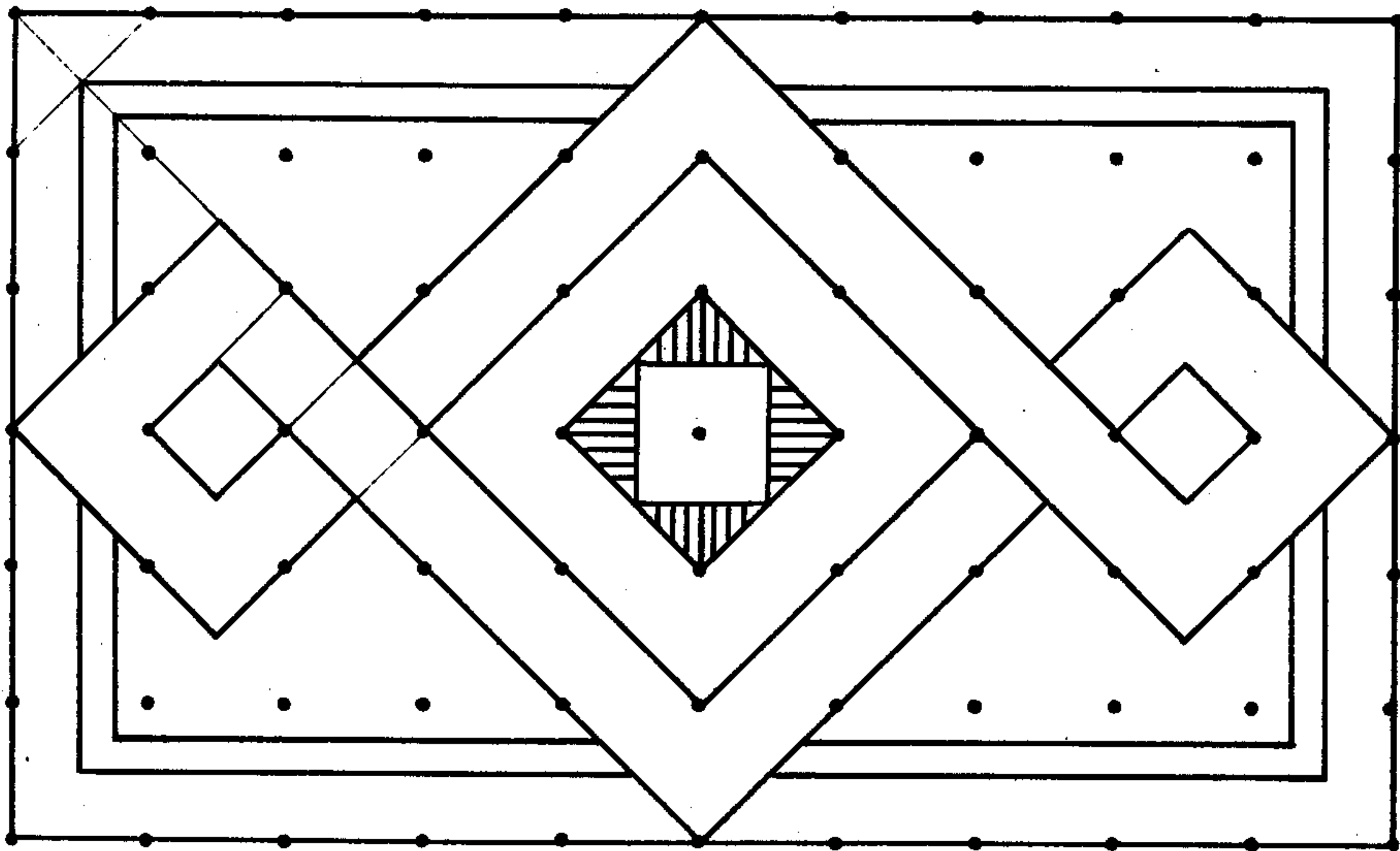

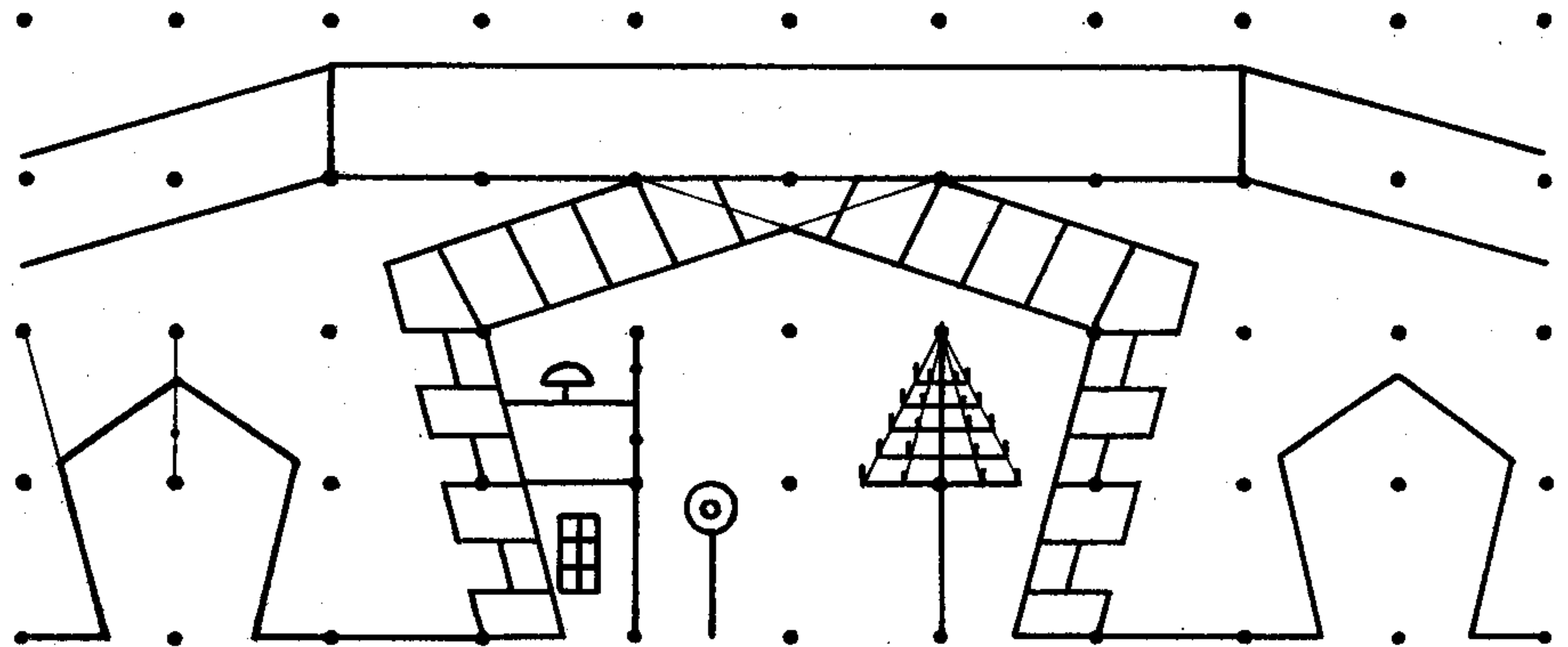
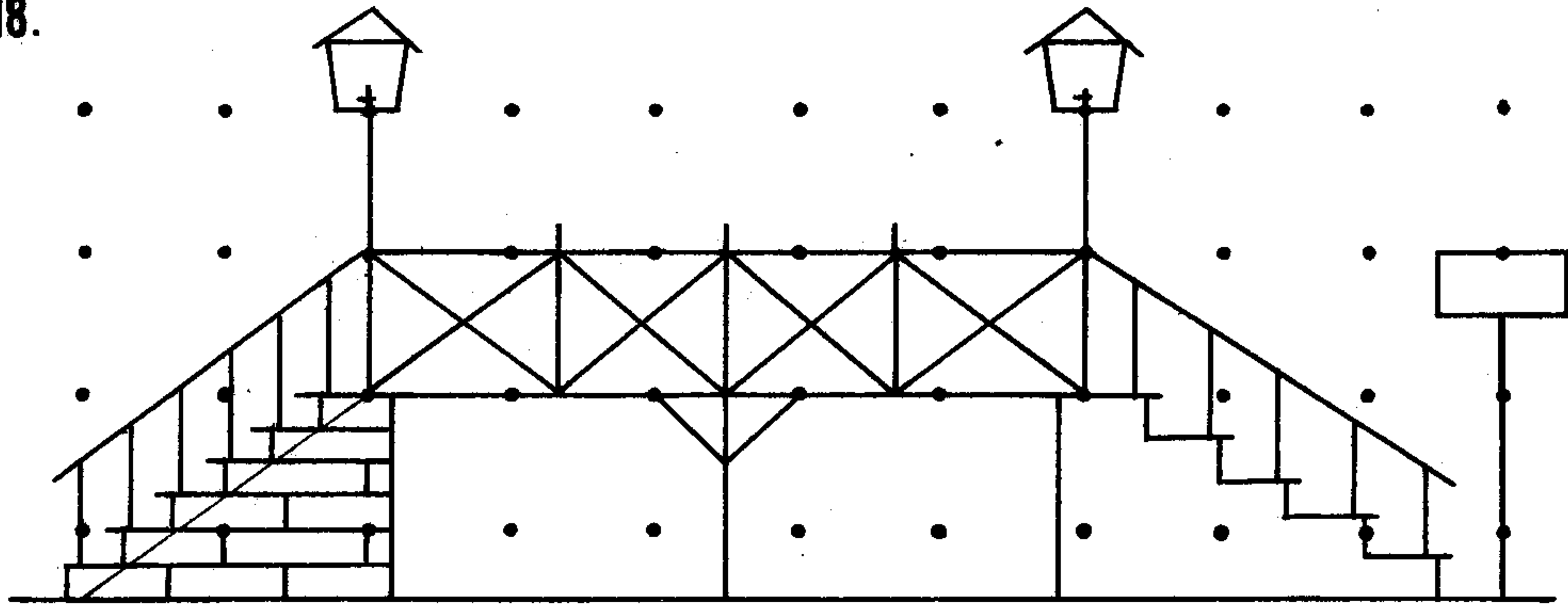



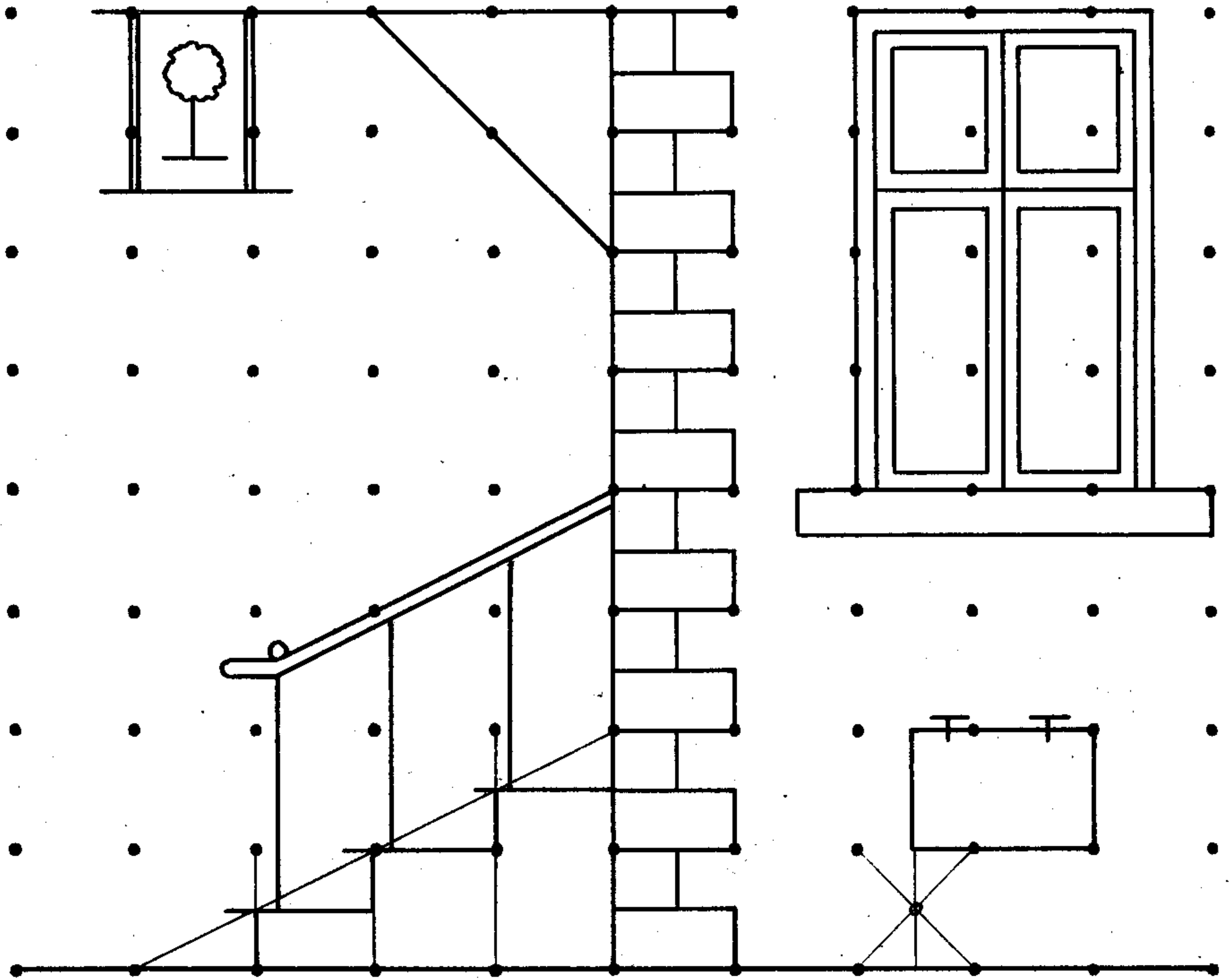

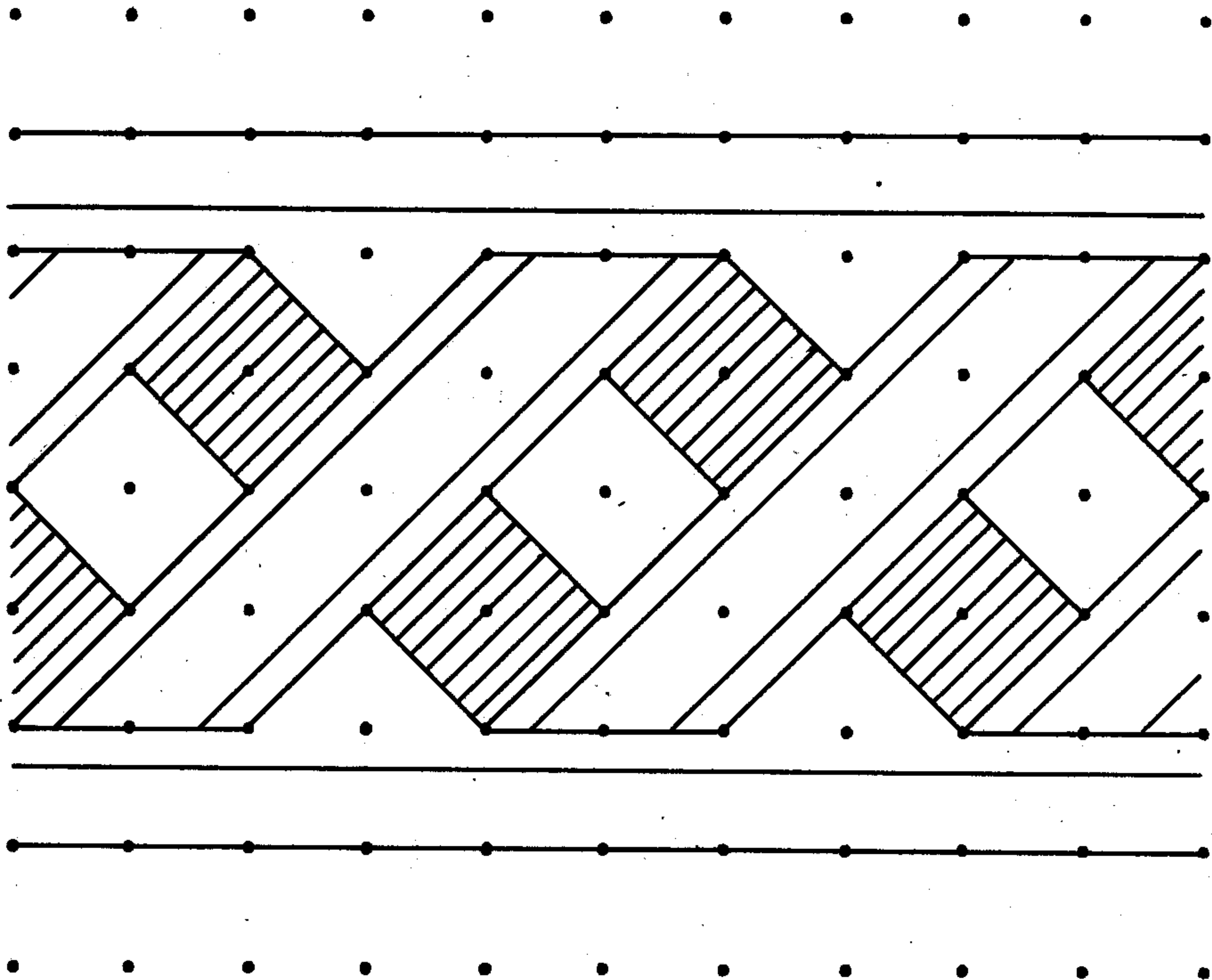

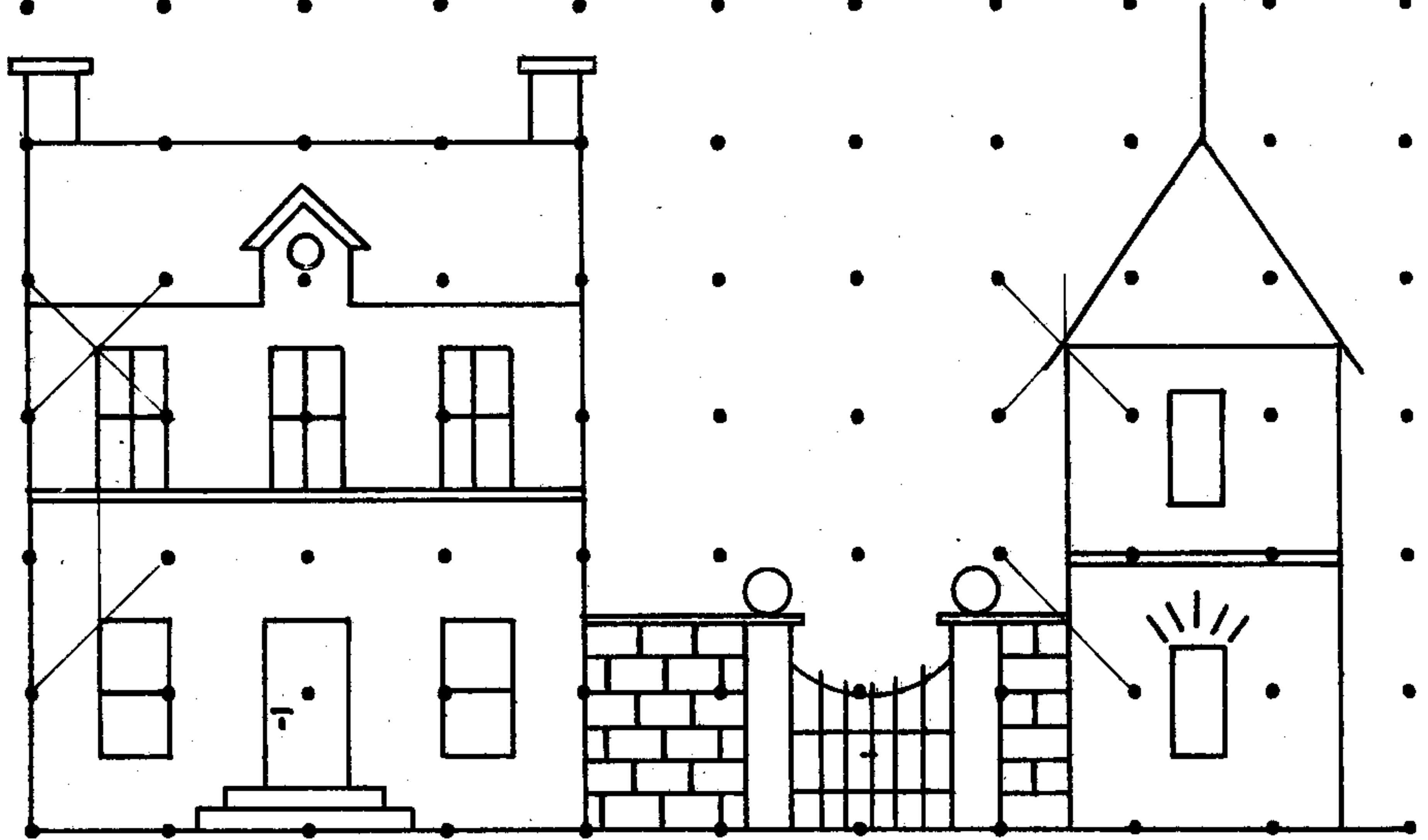

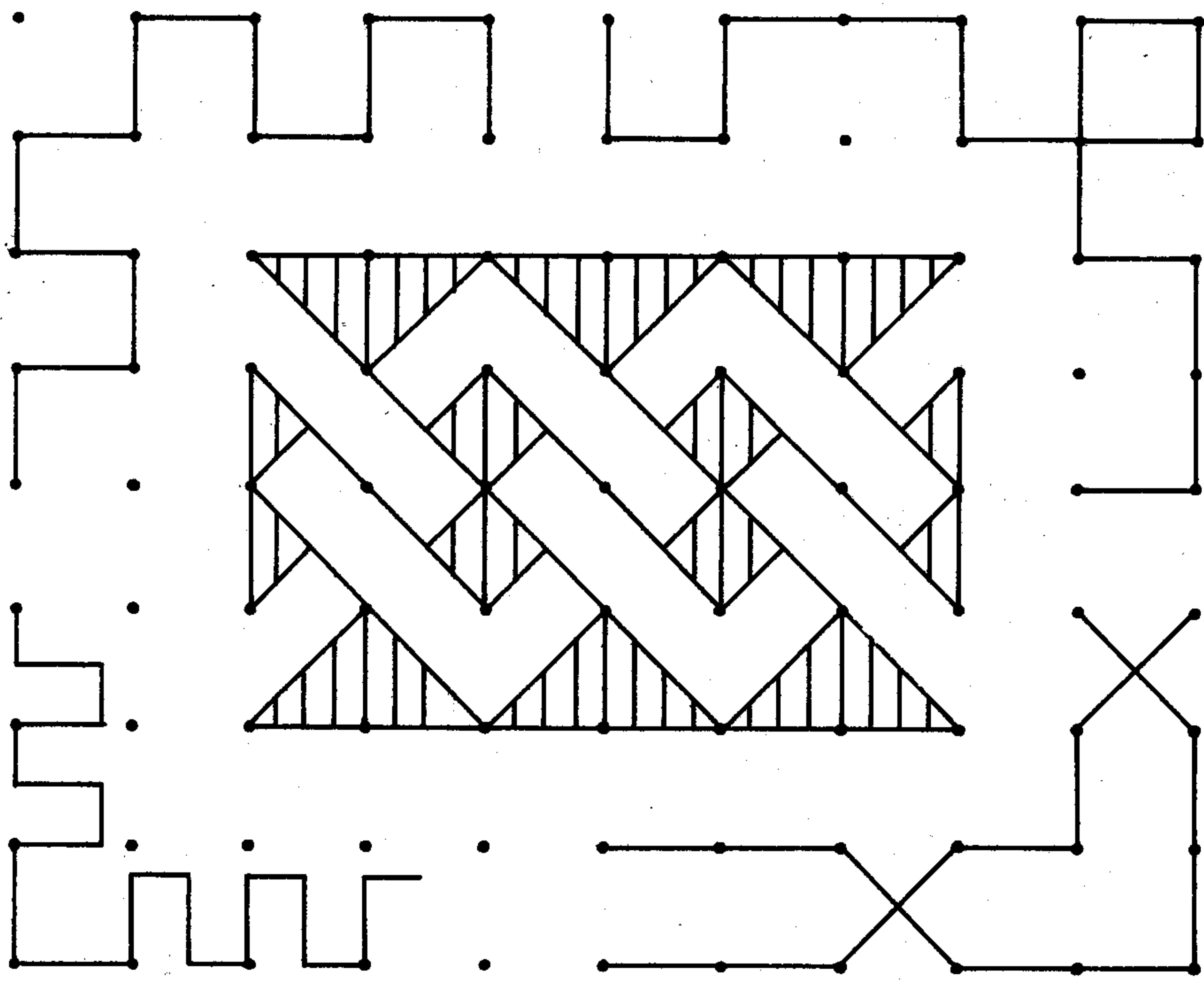



# Schule des Freihandzeichnens.

Auf Grund der gesetzlichen Bestimmungen für österreichische Schulen in concentrischen Kreisen bearbeitet von

**A. Fellner,**

und

**F. Steigl,**

k. k. Bez. Schulinsp. u. Bürgerschul-Director in Wien.

prov. Bürgerschul-Director in Wien.

1. Theil (1. Schulj.) mit 36 lith. Tafeln, 2. Aufl. M. 1.20 = 60 kr.
2. Theil (2. Schulj.) mit 42 lith. Tafeln, 2. Aufl. M. 1.40 = 70 kr.
3. Theil (3. Schulj.) mit 43 lith. Tafeln, 2. Aufl. M. 1.40 = 70 kr.
4. Theil (4. Schulj.) mit 46 lith. Tafeln, 2. Aufl. M. 1.60 = 80 kr.
5. Theil (5. Schulj.) mit 47 lith. Tafeln, 2. Aufl. M. 1.60 = 80 kr.
6. Theil (6. Schulj.) mit 65 Tafeln, mehreren farbigen Figuren und Text.  
2. Aufl. M. 2.40 = fl. 1.20.
7. Theil (7. Schulj.) mit 60 Tafeln, mehreren farbigen Figuren, Perspective und Text. 2. Aufl. 3 M. = fl. 1.50.
8. Theil (8. Schulj.) mit 28 Tafeln in vielfachem Farbendruck in Mappe.  
5 M. = fl. 2.50.

I.—VIII. Theil mit hoh. k. k. Ministerial-Erlass vom 10. Mai 1882, Z. 15196, und vom 17. März 1885, Z. 3140 zulässig erklärt.